



OPERATION MANUAL

FOR

MODEL 8400B

“AUTOSAL”

NOTICE

The contents and information contained in this manual are proprietary to Guildline Instruments Limited. They are to be used only as a guide to the operation and maintenance of the equipment with which this manual was issued, and may not be duplicated or transmitted by any means, either in whole or in part, without the written permission of Guildline Instruments Limited.

**OM8400B-L1-00
27 January, 2025**

TABLE OF CONTENTS

1. INTRODUCTION.....	1-1
1.1. SCOPE.....	1-1
1.2. UNIT DESCRIPTION	1-1
1.2.1. APPLICATION	1-1
1.2.2. PHYSICAL LAYOUT	1-1
1.3. CARE AND HANDLING	1-1
1.3.1. USAGE.....	1-1
1.3.2. CARRYING/TRANSPORTATION/STORAGE	1-1
1.3.3. MAINTENANCE REQUIREMENTS	1-2
1.3.4. RECEIVING AND INSPECTION	1-2
2. SPECIFICATIONS.....	2-1
2.1. GENERAL SPECIFICATIONS.....	2-1
2.2. PERFORMANCE.....	2-2
3. OPERATING DATA.....	3-1
3.1. MEASUREMENT THEORY	3-1
3.2. SAMPLE WATER FLOW ARRANGEMENT	3-3
3.3. BATH TEMPERATURE CONTROL.....	3-4
3.4. SAMPLE FLOW RATE	3-4
3.5. CONDUCTIVITY MEASURING CIRCUIT	3-4
3.6. DISPLAY CIRCUITRY	3-4
4. CONTROLS AND INDICATORS	4-1
4.1. GENERAL	4-1
4.2. CONTROLS.....	4-1
4.3. INDICATORS.....	4-2

5.	INSTALLATION.....	5-1
5.1.	GENERAL	5-1
5.2.	PROCEDURE.....	5-1
5.2.1.	PRELIMINARY CHECK.....	5-1
5.2.2.	TEMPERATURE BATH FILLING	5-2
5.2.3.	PRELIMINARY FUNCTION CHECK.....	5-3
5.2.4.	BATH TEMPERATURE CONTROL CHECK	5-3
5.2.5.	CONDUCTIVITY CELL CHECK.....	5-4
6.	OPERATING INSTRUCTIONS.....	6-1
6.1.	GENERAL	6-1
6.2.	OPERATING SEQUENCE.....	6-1
6.2.1.	CHECKING ZERO REFERENCE.....	6-1
6.2.2.	STANDARDIZATION PROCEDURE.....	6-2
6.2.3.	SAMPLE MEASURING PROCEDURE	6-3
6.3.	CONVERTING INSTRUMENT READING TO SALINITY.....	6-5
6.4.	STANDARD OPERATING PRACTICES.....	6-6
6.5.	MEASURING FOR OPTIMAL ACCURACY.....	6-6
6.5.1.	INSTRUMENT ACCURACY.....	6-6
6.5.2.	PROCEDURAL REFINEMENTS	6-6
6.6.	SAMPLE HANDLING FOR OPTIMAL ACCURACY	6-7
6.6.1.	METHOD TO REMOVE SAMPLE BOTTLE AND LEAVE CELL FULL.....	6-7
6.6.2.	METHOD TO REMOVE WATER FROM PICKUP TUBE PRIOR TO MEASURING NEW SAMPLE.....	6-8
7.	INSTALLATION AND OPERATING INSTRUCTIONS FOR OPTIONAL BCD OUTPUT	7-1
7.1.	GENERAL	7-1
7.2.	BCD CONNECTOR PIN CODE	7-1
7.3.	OPERATING PROCEDURE.....	7-1
8.	GENERAL TECHNICAL INFORMATION.....	8-1
8.1.	INSTRUMENT COMPONENT LOCATION	8-1
8.1.1.	CABINET	8-1
8.1.2.	CHASSIS.....	8-1

9.	THEORY OF OPERATION.....	9-1
9.1.	GENERAL	9-1
9.2.	POWER SUPPLY	9-1
9.3.	TEMPERATURE CONTROL CIRCUIT.....	9-1
9.4.	CONDUCTIVITY MEASURING CIRCUIT	9-1
9.5.	METER ASSEMBLY.....	9-2
9.5.1.	METER CIRCUIT	9-2
9.5.2.	DISPLAY CIRCUIT.....	9-2
10.	MAINTENANCE.....	10-1
10.1.	INTRODUCTION	10-1
10.2.	GENERAL INSPECTION.....	10-1
10.3.	GENERAL CLEANING.....	10-1
10.4.	OPENING THE CABINET	10-1
10.5.	BATH TEMPERATURE VERIFICATION TEST	10-2
10.6.	DISPLAY METER TEST	10-2
10.7.	HEATER LAMP REPLACEMENT.....	10-3
10.8.	CONDUCTIVITY CELL REMOVAL.....	10-3
10.9.	PUMP SERVICING	10-4
10.9.1.	SERVICE INSTRUCTIONS	10-4
11.	SERVICING AND CALIBRATION	11-1
11.1.	GENERAL	11-1
11.2.	MAINTENANCE SCHEDULE.....	11-1
11.3.	SERVICE NOTES.....	11-1
11.3.1.	CLEANING FLUSHING MANIFOLD/TUBES	11-1
11.3.2.	CHECKING THERMOELECTRIC COOLING UNIT	11-3
11.3.3.	CHECKING IMPELLER	11-3
11.3.4.	CHECKING HEATER LAMPS	11-3
11.3.5.	REMOVING TOP PANEL.....	11-3
11.3.6.	REMOVING TANK.....	11-4

11.4.	AUTOSAL CALIBRATION	11-4
11.4.1.	POWER SUPPLY CALIBRATION	11-5
11.4.2.	CONDUCTIVITY PCB CHECK	11-5
11.4.3.	METER CALIBRATION	11-7
11.4.4.	MATCHING AND BALANCING	11-7
12.	TROUBLESHOOTING	12-1
12.1.	GENERAL	12-1
13.	RECOMMENDED SPARE PARTS	13-1
13.1.	STANDARD SPARE PARTS.....	13-1
13.2.	MAINTENANCE KIT	13-1
13.3.	PUMP MOTOR REPLACEMENT KIT.....	13-1

TABLE OF FIGURES

FIGURE 3.1: LABORATORY SALINOMETER FLOW DIAGRAM	3-2
FIGURE 4.1: FRONT PANEL.....	4-3
FIGURE 7.1: CONNECTOR PINOUTS.....	7-2
FIGURE 8.1: CHASSIS BACK	8-2
FIGURE 8.2: FRONT PANEL.....	8-3
FIGURE 8.3: TOP PANEL	8-4
FIGURE 11.1: CONDUCTIVITY CELL SIMULATOR.....	11-8

LIST OF TABLES

TABLE 2-1: GENERAL SPECIFICATIONS.....	2-1
TABLE 2-2: PERFORMANCE	2-2
TABLE 7-1: BCD CONNECTOR PIN CODING.....	7-2
TABLE 11-1: MAINTENANCE SCHEDULE.....	11-2
TABLE 11-2: OPERATING CHECKS SCHEDULE.....	11-2
TABLE 11-3: SIMULATION RESISTANCES	11-11
TABLE 12-1: TROUBLESHOOTING GUIDE.....	12-5

1. INTRODUCTION

1.1. SCOPE

This manual contains technical specifications, detailed description and maintenance information, parts lists, and diagrams for the Guildline Instruments 8400B AUTOSAL "Laboratory Salinometer".

1.2. UNIT DESCRIPTION

1.2.1. APPLICATION

The instrument is semi-portable, semi-automatic, and is used in the land based or sea-borne laboratory to determine salinity levels in saline samples by measuring the equivalent conductivity ratio to a standard seawater sample.

1.2.2. PHYSICAL LAYOUT

The instrument is enclosed in an aluminum cabinet measuring 68 cm high, 53 cm wide and 55 cm deep; maximum total weight is approximately 70 kg. The cabinet incorporates a flushmounted handle on each side for easy carrying and is designed for bench mounting. The instrument chassis is held in place in the cabinet on four track slides for easy withdrawal from the front by removing four polished binder head screws. Removing the three left-hand screws allows the front panel to hinge out. All primary controls, indicators, and the adjustable sample bottle holder, cell inspection window and external tubing connections are located on the front panel. Power input, 120/240 volt switching and the BCD OUTPUT connector are located on the rear panel.

1.3. CARE AND HANDLING

1.3.1. USAGE

Although this instrument is designed for high precision measurement it is quite rugged. It requires only reasonable care and good maintenance practices to ensure optimum performance. It can withstand continuous operation and if required, long periods between operations.

1.3.2. CARRYING/TRANSPORTATION/STORAGE

The handles provided on the sides of the cabinet provide the easiest, safest means of lifting the instrument. Use the valves provided to drain the internal fluids and so reduce weight, prevent possible leakage during transportation, and to prevent damage if subjected to below freezing temperatures. A tank drain plug is provided with the unit for eliminating drips from the nipple during transportation.

1.3.3. MAINTENANCE REQUIREMENTS

Use the maintenance schedule (Section 10) as a guide for planning the implementation of the recommended, in-service maintenance.

1.3.4. RECEIVING AND INSPECTION

This instrument is thoroughly tested and inspected before packing and shipping. As soon as possible after receipt, inspect the instrument for external damage, ensure that all items in the packing list are present, and complete the installation checks. Refer to the warranty card at the front of this manual for further instruction if any damage or deficiency is found.

2. SPECIFICATIONS

2.1. GENERAL SPECIFICATIONS

MODEL 8400B General Specifications			
Operating Temperature	14 to 35 57 to 95	°C °F	
Storage Temperature	-20 to +60 -4 to +140	°C °F	
Operating Humidity (non-condensing)	20 to 50	% RH	
Storage Humidity (non-condensing)	15 to 80	% RH	
Power Requirements	400	W	
Voltage Requirements	115/230 ±10%	VAC	
Line Frequency	50/60	Hz	
Dimensions (Nominal)	68 high X 53 wide X 55 deep 27 high X 21 wide X 22 deep	cm in	
Weight	Bath empty	52 115	kg lb
	Bath full	70 150	kg lb
	Shipping	88 193	kg lb
Outputs: TTL compatible BCD	<ul style="list-style-type: none"> - numerical display readings, - thumbwheel switch bottle logger 		
Water Bath Volume	16.8	litres	
	4.4	gal US	

Table 2-1: General Specifications

2.2. PERFORMANCE

Measurement Range:	0.005 to 42	PSU	
24 Hour Accuracy:	better than ± 0.002 (In the range of 2 – 38)	PSU	over 24 hours without restandardization
10 Minute Stability:	better than ± 0.0006 (In the range of 2 – 38)	PSU	over 10 minutes equivalent to ± 0.00003 units of display
Maximum Resolution:	better than ± 0.0002	PSU	at 35 PSU
Sample Volume:	100	ml	including maximum flushing volume
	50	ml	for 3 PSU difference between samples
Water Bath Temperature:	18 to 33	$^{\circ}\text{C}$	Selectable in 3°C steps
	± 0.02	$^{\circ}\text{C}$	selected temperature should be within [ambient + 4] $^{\circ}\text{C}$ and [ambient - 2] $^{\circ}\text{C}$
	± 0.001	$^{\circ}\text{C}/\text{day}$	

Scale Suppression: Linear scale of conductivity ratio having 22 steps from 0 to 2.2 where 2.0 corresponds to sea-water of 35 PSU (maximum reading is 2.29999, corresponding to a salinity of approximately 42 PSU).

Table 2-2: Performance

3. OPERATING DATA

3.1. MEASUREMENT THEORY

The instrument permits measurement of the electrical conductivity ratio of saline samples at a controlled temperature. Once measured, the conductivity ratio can be used to determine salinity through the use of a conversion table or the application of a mathematical equation.

Low pressurized air forces the saline sample from the sample bottle and through the sampling element which is called a conductivity cell. The sample passes as a continuous flow through the conductivity cell. Electrodes implanted in the cell initiate signals that are proportional to the sample's conductivity. Using an internal preset electrical reference to produce an error signal, the instrument provides a numerical readout, which corresponds in magnitude and direction to the error signal. The display reading provides a valid measurement value when the internal reference has been preset, or standardized, against a known external reference. Standardization, using IAPSO recognized sea-water standards, is accomplished by operating the instrument as for a routine conductivity ratio measurement with the standard sea-water and making adjustments as necessary to the instrument so that the reading corresponds with the known conductivity ratio for that particular standard seawater.

In practice the instrument is calibrated so that the displayed reading is a 2 to 1 conductivity ratio of the measured sample to standard sea-water. The resolution of the instrument is such that the last digit is approximately equivalent to 0.000 2 PSU at 35 PSU. At this level of accuracy, fluctuation of the last digit by up to five counts (± 0.001 PSU) is of minor significance to the total reading.

In preparation for measurement of the conductivity ratio the following two functions are initiated by the operator:

- (a) Temperature selection - to enable the sample temperature to stabilize at a precise preset level prior to the conductivity ratio measurement;
- (b) A flushing action - to enable systematic purging of the conductivity cell, thereby ensuring that no residue from the previous sample remains. Residue from the previous sample would degrade sample purity. Not more than 100 ml is required to measure any sample, starting from fresh water in the conductivity cell and including flushing volume. Only 50 ml is required if the difference in salinity from the previous sample is not greater than 3 PSU.

Due care must be exercised in preparation and handling of samples in order to ensure accurate results. For instance, a single drop of rainwater in a sample bottle, or mere hand contact introducing salts from skin moisture into the sample water, may be enough to cause measurable errors in salinity.

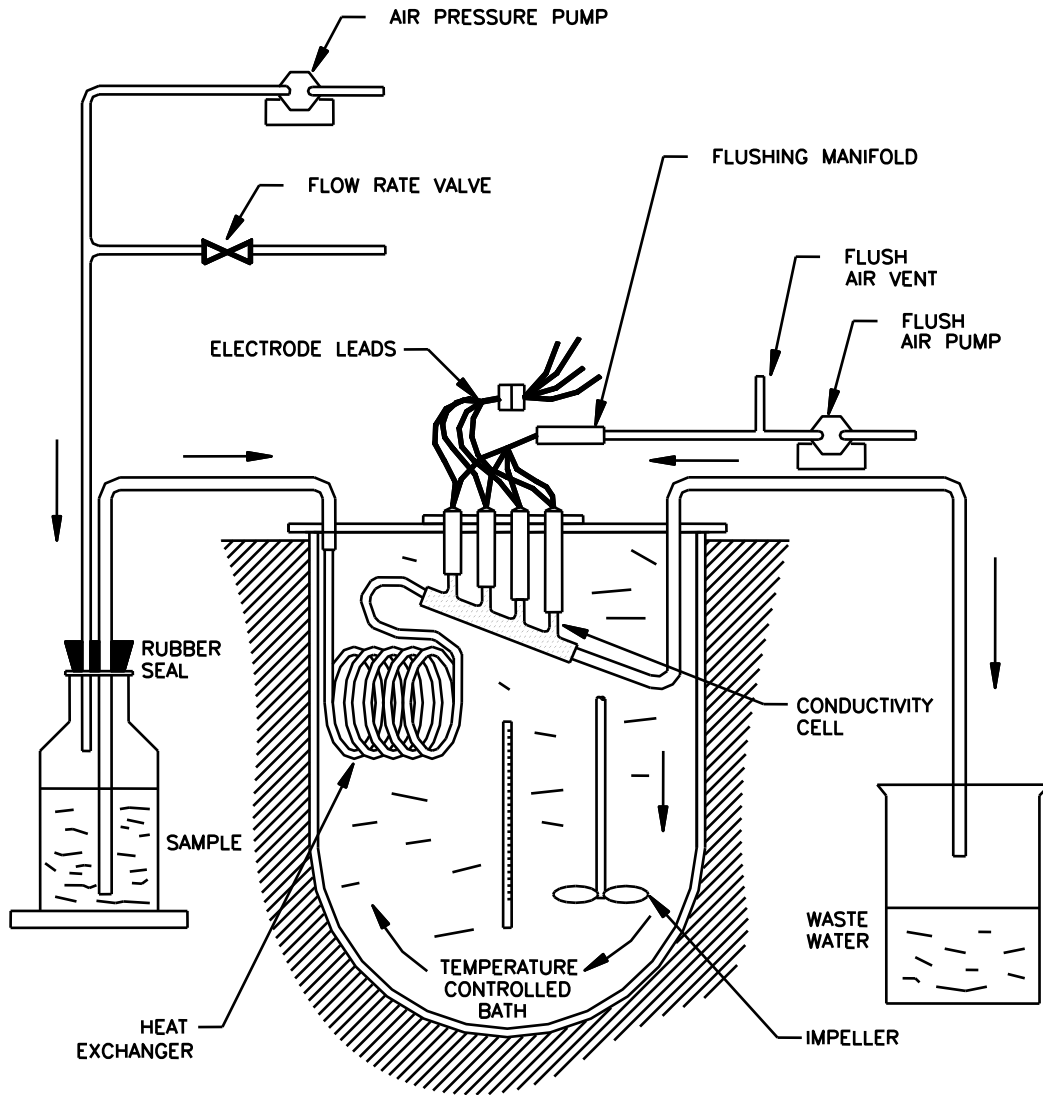

Figure 3.1: Laboratory Salinometer Flow Diagram

3.2. SAMPLE WATER FLOW ARRANGEMENT

The tank configuration is shown in Figure 3.1. The tank is insulated with polyethylene foam and has a gasket seal around the top. It has a rectangular cross section with a divider in the middle and a smooth curved bottom to reduce turbulence and avoid dead zones. Bath circulation is achieved by an impeller driven by a small motor mounted above the tank. Bath volume is about 17 litres and cycle time for the water is about 15 seconds. The sequence of water flow is from the impeller to the heat exchanger coil which is mounted near the tank divider then to the cell. In the space between the heat exchanger and the side of the bath are two 40-watt tubular incandescent lamps located so that any water heated passes the impeller for mixing before striking any critical component. On the side of the bath, by the lamps, is the cold element of a thermoelectric cooling unit which runs continuously. Two thermistors located near the conductivity cell act as the temperature sensors. A bulb behind the front panel illuminates the conductivity cell.

The sample bottle is placed in the holder with its neck pressing against an air seal and the thin Teflon pick-up tube projecting almost to the bottom. Making the seal allows low pressure air from a pump to build up pressure above the sample, forcing a slow flow (30 ml/min) through the pick-up tube into a coil of stainless steel heat exchange tubing which is mounted in the precisely thermostatted water bath. The flow of the sample, now at bath temperature, passes through a Teflon tube to the Pyrex conductivity cell. Once the cell is filled the sample exits from the other end of the cell through a plastic tube and out of the tank to a larger tube which leads to a drain spigot.

The four electrodes of the cell are platinum-rhodium coils mounted in side arms spaced along the upper side of the cell as shown. The two outer arms are used as potential leads and the inner arms as current leads. In addition to the electrical lead each side arm accommodates a very fine Teflon tube which serves as an air vent so that the side arm can fill with water. The cell is mounted at an angle of about 15° allowing the cell to be emptied by forcing air down the Teflon tubes into the side arms. Back flow of water in the heat exchanger is prevented by the higher filling pressure. After flushing, the cell refills via the inlet tube with the first water running along the bottom of the cell to clean out the previous water. As soon as the cell has been filled above the electrodes, readings can be taken, or, alternatively, a new flush can be started.

The end of the pick-up tube in the sample bottle is located slightly lower than the conductivity cell; consequently, if the cell empties just before removing the bottle the water in the tube will siphon slowly away from the cell thus causing backflow of old sample into the new one. To prevent the backflow of sample water, a Mylar pickup tube holder has been provided. Insert the pickup tube into the holder to initiate siphoning towards the cell. Once the sample water reaches the bend in the pickup tube, it will continue to siphon towards the cell. This also creates a plug of air to separate the old and new water in the heat exchanger. The thermostatted bath has a window facing the operator to allow full viewing of the cell.

Air pressure for driving the water and for cell flushing is provided by two piston type pumps, which can be switched on or off. Flushing is initiated by blocking a panel mounted control orifice, thus diverting the air to the electrode arms and driving the water out of the cell.

3.3. BATH TEMPERATURE CONTROL

A precision control system maintains the bath water temperature at one of six selectable settings in the range 18°C to 33°C in increments of three degrees. Two incandescent bulbs provide the bath heating source while a thermoelectric cooling unit provides the cooling. Steadily lighted during a "heat on" cycle and darkened during a "heat off" cycle, the heater lamps flash on and off in regular sequence, providing visual indication when bath temperature reaches the selected setting. The temperature control range enables cooling of the bath to room temperature minus 2°C and heating to room temperature plus 4°C.

3.4. SAMPLE FLOW RATE

It is not possible to obtain a stable reading from a sample which has not achieved bath temperature due to a combination of a large sample to bath temperature difference and a high flow rate. If the flow rate is too fast the heat exchanger will be unable to bring the sample to the correct temperature. Unstable or incorrect readings will result. If the flow rate is too slow an excessive amount of time will be required to fill the cell and to obtain a reading. If the flow rate is too fast the indication will be a marked change in the cycling of the heater lamps. A cold sample will cause an "ON" period. The flow rate should be reduced until the normal cycling of the heater lamps is restored.

3.5. CONDUCTIVITY MEASURING CIRCUIT

The conductivity circuit measures the resistance of the cell by maintaining a precise voltage across the potential arms of the four terminal resistor (cell) and measuring the voltage across a stable resistor in series with the cell current arms. The current is a square wave alternating current to prevent polarization of the sample.

3.6. DISPLAY CIRCUITRY

The output from the conductivity measuring circuit is changed to a binary coded decimal number and this number is displayed on a 4 digit LED (light emitting diode) readout and is available for electronic data logging through the rear panel BCD connector. The analog to decimal conversion is performed by a commercial 4½ digit analog to digital integrated circuit system.

4. CONTROLS AND INDICATORS

4.1. GENERAL

All primary instrument controls and indicators are located on the front panel. The main power, voltage select switch and main supply fuse are mounted on the rear panel exterior. Figure 4.1 identifies the front panel controls and indicators as well as some other functional items.

4.2. CONTROLS

- (a) **FLOW RATE:** This valve regulates the flow of the sample water by controlling the air pressure in the sample bottle. A flow rate of 30 ml/min is available with flow rate valve at maximum (valve fully clockwise). Decreasing the flow rate allows more time for the sample temperature to equal bath temperature before sample water enters the conductivity cell.
- (b) **TANK DRAIN:** This valve must be open (fully counter-clockwise) when filling or draining the tank through the TANK DRAIN/FILL spigot; closed when filling through top tank opening and for all other operations.
- (c) **CHECK HEATER:** This indicator lights continuously when one of the heater lamps is open circuit.
- (d) **PUMPS:** This switch is normally left in the **OFF** position unless filling or flushing the conductivity cell.
- (e) **TEMPERATURE-SET C:** This six-position switch selects 18°C, 21°C, 24°C, 27°C, 30°C or 33°C bath temperatures. The bath temperature must be set within -2°C to +4°C of room temperature.
- (f) **TEMPERATURE SENSOR:** This three-position switch is left in the **NORMAL** position except to check thermistor sensor operation when positions 1 and 2 are used.
- (g) **STANDARDIZE:** This ten-turn vernier potentiometer (with 100 divisions-per-turn scale and locking arm) is used with the **FUNCTION** switch in the **READ** position when standardizing the instrument.
- (h) **FUNCTION:** This switch has three positions. In the **ZERO** position, the display indicates if the zero reference has drifted. In the **READ** position, the display indicates twice the conductivity ratio of the sample to the standard. In the **STANDBY** position, the first two digits of the display indicate the setting of the **TEMPERATURE SET °C** switch. A change in the reading of the last four digits indicates the **STANDARDIZE** control setting has changed or the electronics has drifted from the last standardization.

- (i) **SUPPRESSION:** This 23-position switch is used with the **FUNCTION** switch in the **READ** position to obtain the first two digits in the display during measurement and standardization. This control acts as a range switch. Whenever the saline sample is outside the range of the **SUPPRESSION** switch setting, the display flashes on and off. This control is adjusted until the display indicates a positive reading and ceases to flash.
- (j) **FLUSH:** This air vent controls the air pressure in the conductivity cell flushing manifold. Covering the vent with the finger causes the sample water in the conductivity cell to discharge through the **CELL DRAIN** spigot.
- (k) **115 V/230 V:** Located on rear panel, this switch is used to prepare the instrument power circuits so as to accept either 115 V or 230 V main supply.
- (l) **DATA LOG:** Momentary pushbutton switch provided with the BCD output to enable a trigger signal for an external device (printer, recorder, computer etc.).
- (m) **POWER:** This switch, located at the rear next to the line cord receptacle, is normally left on to maintain water bath temperature.

4.3. INDICATORS

- (a) **DIGITAL DISPLAY:** The display is arranged as follows: digit, decimal point, digit, + or - sign, digit, digit, digit, digit. The position of the **FUNCTION** switch determines what is displayed. The decimal point appears only when the **FUNCTION** switch is in the **READ** or **ZERO** position.
- (b) **BOTTLE NUMBER:** This four-section thumb wheel switch provides a mechanical numeric display to identify the sample. It is used with the **DATA LOG** pushbutton for data logging samples via the **BCD OUTPUT** connector.

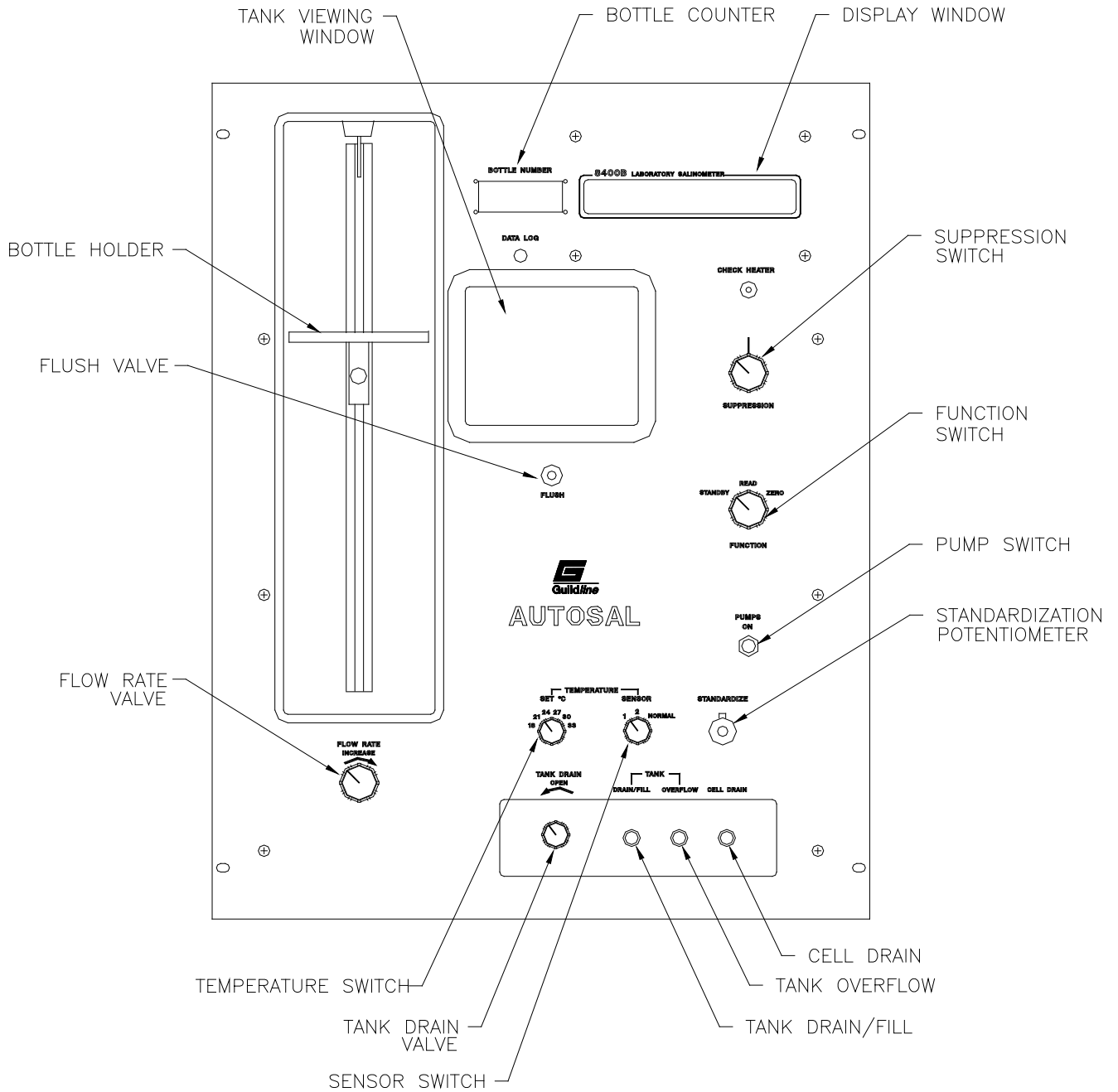

Figure 4.1: Front Panel

5. INSTALLATION

5.1. GENERAL

Installation of the instrument entails:

- (a) setting the instrument on a suitable platform with space beneath for two wide-mouth plastic containers (one to catch possible tank overflow or drain water and one to catch waste sample water), and within reaching distance of 115 V or 230 V ac supply and, if possible, a water tap.
- (b) connecting the supplied sample water tubing.
- (c) filling the tank with distilled water. Allow for at least one hour after start-up for the tank temperature to stabilize at room temperature.
- (d) connection to BCD output, if appropriate (refer to Section 7 for details).

The supplied Standard Spare Parts Package (section 13) contains the required electrical supply fuse, tubing and associated fittings, in addition to miscellaneous parts used for special requirements.

5.2. PROCEDURE

Place the instrument close to edge of operating platform so tubing from drain and overflow spigots can lead straight downward to waste containers, then proceed with the following procedures in sequential order.

5.2.1. PRELIMINARY CHECK

Step 1. Perform initial start-up as follows:

- a) Ensure 115/230 V switch at bottom of rear panel is set to correct line voltage. Check supplied fuse in fuse holder (110 V to 120 V, 4 A slow-blow; or 220 V to 240 V, 2 A slow-blow as appropriate).
- b) Plug line cord into socket at bottom of rear panel and into line supply outlet. Ensure **FUNCTION** switch is set to **STANDBY**.
- c) Switch power on.

Step 2. Check the cooling fans, by feeling for air flow at the openings at the rear.

- Step 3.** Remove four front panel binder head screws; do not withdraw instrument from cabinet, and be careful to ensure it does not inadvertently roll out on its tracks as the cabinet is not heavy enough to counter-balance the weight of the chassis when fully extended.
- Step 4.** Remove three screws to the left of the bottle holder.
- Step 5.** Carefully swing open the front panel.
- Step 6.** Observe that the tank impeller operates, as seen through the lower right hand corner of the tank window or by the rotation of O-ring belt driven pulley on top of the tank.
- Step 7.** Check that all internal tubing connections are secure.
- Step 8.** Close and secure front panel, using oval Phillips head screws and binder head screws.
- Step 9.** Switch power off and disconnect line cord from AC supply.

5.2.2. TEMPERATURE BATH FILLING

There are two convenient methods of filling the temperature bath:

- (a) by connecting tank fill tube to water tap using suitable hose adapter.

or if not within reach of water tap,

- (b) by siphoning water into tank through a hose from a container higher than the bath.

NOTE: Filling the bath with water at or near room temperature reduces tank temperature stabilization time.

To reduce the likelihood of algae growth in the bath, use distilled water or add an algae inhibitor to the water. Care should be taken to ensure that any additives do not have corrosive properties.

5.2.2.1.HOSE METHOD

- Step 1.** Connect two suitable lengths of 9.4 mm (.37 in) ID plastic tubing to **TANK DRAIN/FILL** and **TANK OVERFLOW** spigots.
- Step 2.** Connect a funnel to the end of the **TANK DRAIN/FILL** tube. Elevate the funnel approximately 1 metre (39 in.). Open the **TANK DRAIN** valve (fully counterclockwise) and pour the algae inhibitor solution into the funnel.

- Step 3.** Close **TANK DRAIN** valve (turn fully clockwise) remove funnel and connect **TANK DRAIN/FILL** tube to water tap.
- Step 4.** Open **TANK DRAIN** valve completely. Then Slowly, so as not to build up excessive pressure, turn on tap and fill tank until water starts to discharge from **TANK OVERFLOW** tube. Turn tap off.
- Step 5.** Close **TANK DRAIN** valve; disconnect **TANK DRAIN/FILL** tube from water tap end and spigot end and remove.
- Step 6.** Disconnect and remove **TANK OVERFLOW** tube and seal spigot with supplied overflow drain plug.

5.2.3. PRELIMINARY FUNCTION CHECK

- Step 1.** Connect line cord to socket at bottom of rear panel and line supply outlet. Switch power on.
- Step 2.** Switch pumps on. Ensure air flow discharges from **FLUSH** air vent. Switch pump off.
- Step 3.** Set **FUNCTION** switch to **ZERO** (the display reads all zeros, ± 5 digits).
- Step 4.** Set **TEMPERATURE SET °C** switch to 33 and **TEMPERATURE SENSOR** switch to **NORMAL** (both heater lamps should light) if water **TEMPERATURE** is below 33°.
- Step 5.** Set **TEMPERATURE SET °C** switch to 18 (both heater lamps should remain off if bath water temperature is above 18°C).
- Step 6.** Set **FUNCTION** switch to **STANDBY** (the first two digits of display read 18 - last four digits are insignificant).

5.2.4. BATH TEMPERATURE CONTROL CHECK

- Step 1.** Set **TEMPERATURE SET °C** switch to within -2°C and +4°C of ambient temperature, wait until bath has reached set temperature (indicated by regular on and off cycling of heater lamps).

NOTE: For a newly filled bath, where water may not be close to room temperature, the wait period may be of several hours. As an expedience for this check only, setting of the temperature as close as possible to bath water temperature is permissible.

- Step 2.** Set **TEMPERATURE SENSOR** switch to **NORMAL**. Wait until both heater lamps are cycling steadily.

Step 3. Set **TEMPERATURE SENSOR** switch first to 1 and then to 2, check that the two heater lamps are initially on or off but begin to cycle within 4-5 minutes on each position.

Step 4. Return **TEMPERATURE SENSOR** switch to **NORMAL**.

5.2.5. CONDUCTIVITY CELL CHECK

Step 1. Install pick-up tube and cell drain tube as follows:

- a) Connect suitable length of 9.4 mm (.37 in) ID plastic tube to **CELL DRAIN** spigot.
- b) Arrange tubing so as to drain into waste container, ensuring cell drain arrangement complies with the following important specifications:
 - i. Ensure cell drain tube remains isolated from possible electrical ground paths.

NOTE: If the CELL DRAIN tube provides an electrical leakage path to ground, large intermittent jumps in the display occur. Even a plastic tube with a wet outer wall can cause this error. Arrange the tube so the water discharges into a plastic container (preferably located on the floor) and the tube does not touch the container or its contents.

- ii. Never allow **CELL DRAIN** tube to form traps or loops, causing water to fill an entire cross-section of tube. The resulting siphoning action may empty the conductivity cell.
 - iii. Never elevate **CELL DRAIN** tube above level of cell. Water in the tube may back up to the cell electrode arms, flooding the flushing manifold.
- c) Attach one piece of 1.6 mm (.065 in) ID tubing to metal tube protruding from rubber stopper at sample bottle holder location, cutting tubing so it can reach but not touch bottom of sample bottle.

Step 2. Select a bottle of saline water (any salinity from 5 to 40 PSU) and thoroughly, but gently, agitate to eliminate gradients.

Step 3. Place sample bottle in holder, fitting pickup tube into the bottle. Lock bottle holder shelf in position to form airtight seal at bottle mouth, using knob beneath sliding shelf to lock and unlock shelf.

- Step 4.** Ensure **FUNCTION** switch is set to **STANDBY**. Switch pumps on.
- Step 5.** Observe through tank window that all four arms of the conductivity cell fill sufficiently to cover electrodes. If the cell does not fill completely, press **FLUSH** and allow to refill after increasing flow rate, if necessary to maximum.
- Step 6.** When cell is full, set **FUNCTION** switch to **READ**. Adjust **SUPPRESSION** switch until display stops flashing and shows a positive reading.
- Step 7.** Return **FUNCTION** switch to **STANDBY** setting. And remove sample. Press **FLUSH** for approximately 3 seconds to empty conductivity cell and drain tube. Switch pumps off. Insert pickup tube into pickup tube holder to drain sample water into cell, then flush again.
- Step 8.** Wipe pickup tube with tissue paper to remove sample residue.
- Step 9.** Repeat steps 2, 3 and 4 and then switch pumps off unless immediate instrument use is intended. Power should be left on to keep bath water at constant temperature.

6. OPERATING INSTRUCTIONS

6.1. GENERAL

The instrument operating sequence entails:

- (a) Checking the instrument zero reference to ensure the instrument is properly calibrated.
- (b) Standardizing the instrument to standard sea-water, or checking to ensure previous standardization is still valid.
- (c) Measuring the 2 times conductivity ratio of the sample water.
- (d) Converting the instrument reading to equivalent salinity of the sample.

A properly calibrated instrument will remain standardized provided:

- (a) **STANDARDIZE** control remains unchanged.
- (b) **TEMPERATURE** - °C setting remains unchanged.
- (c) Room temperature is within -4°C and +2°C of **TEMPERATURE** °C setting.

This section includes recommended standard practices associated with the instrument operating sequence. It also describes the techniques for precision measurement.

Before using the instrument and periodically during its use, always routinely check the instrument to ensure the zero reference or calibration has not drifted. If the instrument has been in storage or out of service, refer to Section 5 and to the appropriate installation checks.

6.2. OPERATING SEQUENCE

6.2.1. CHECKING ZERO REFERENCE

- (a) Ensure instrument is powered up per Section 5.2.
- (b) Select **FUNCTION** switch to **ZERO**.
- (c) Check last four digits of display read 0000 (last digit ± 5); instruments whose reading does not conform to this check specification require recalibration as described in the service manual. Note that the stability of this number over time is of more significance than it's actual value.

6.2.2. STANDARDIZATION PROCEDURE

- (a) Thoroughly, but gently, agitate a bottle or vial of standard sea-water and open (to open vial, score glass, across end piece, and snap off). Insert open end of vial into the large end of supplied cylindrical adapter, ensuring snug fit. Standard seawater in bottles generally will not require the adapter.
- (b) Insert pickup tube through adapter and into vial.
- (c) Place vial or bottle in bottle holder. Slide platform up until small end of adapter, or neck of bottle fits tightly inside rubber stopper, forming an airtight seal. Lock platform in position.
- (d) Switch pumps on and flush the conductivity cell three times.
- (e) Allow cell to refill and set **FUNCTION** switch to **READ**. Allow display to stabilize. Adjust **SUPPRESSION** switch until the display stops flashing and indicates a positive reading. Note reading of entire display.
- (f) Set **FUNCTION** switch to **STANDBY**. Flush conductivity cell.
- (g) When cell is full, set **FUNCTION** switch to **READ**. Allow display to stabilize. Note reading of entire display.
- (h) Repeat steps (f) and (g) until three consecutive identical readings are obtained.

NOTE: Do not standardize when the vial or bottle contains less than 15% of its initial volume as errors up to 2 ppm may be introduced due to possible salts concentration.

- (i) Set **FUNCTION** switch to **READ** position and, by means of **STANDARDIZE** control, adjust display reading to agree with 2 times conductivity ratio value obtained from standard sea water vial label.
- (j) Set **FUNCTION** switch to **STANDBY**. Remove standard sea-water vial. Flush conductivity cell with fresh water to remove salt deposits and switch pumps off. Insert end of pickup tube into pickup tube holder to drain. Wipe tube with tissue paper.

- (k) With **FUNCTION** switch set to **STANDBY**, record last four digits of display.

NOTE: These four digits are used as a standardization indicator. If these four digits change to a different reading with FUNCTION switch on STANDBY the instrument has electrically shifted. Restandardize as above when change in displayed value is greater than ± 5 last digits.

6.2.3. SAMPLE MEASURING PROCEDURE

NOTE: Samples up to 15 °C below the bath temperature can be measured if the flow rate is reduced sufficiently to allow the sample to reach the bath temperature while in the heat exchanger; however, this practice may not give the most accurate results obtainable. All conductivity measurements are made with the TEMPERATURE SENSOR switch in the NORMAL position.

Step 1. Install sample bottle as follows:

- (a) Check and record sample bottle identity.
- (b) Thoroughly, but gently, agitate to eliminate gradients.
- (c) Open bottle and place in holder, inserting pick-up tube into bottle neck and bottle mouth over rubber seal. Ensure pick-up tube reaches almost to bottom of bottle but not touching such as to restrict flow.
- (d) Adjust and secure platform to ensure airtight seal.

NOTE: The importance of purity of a sample cannot be overstressed. Do not handle the pick-up tube, rubber seal or neck of bottle except with clean tissue for wiping or surgical gloves for handling.

Step 2. Turn on pumps and allow conductivity cell to fill with sample water, adjusting **FLOW RATE** valve for medium flow rate.

Step 3. Flush sample water out of cell by placing fingertip over **FLUSH** air vent.

Step 4. Fill and flush two more times, using **FLUSH** air vent control, while adjusting flow rate to suit sample temperature.

NOTE: A flow rate which is too fast is indicated by a marked change in the on/off cycle of the heater lamps. Slowly reduce the flow rate until the heater lamps cycle normally.

- Step 5. Allow conductivity cell to refill and sample water flow to continue then set **FUNCTION** switch to **READ**.
- Step 6. Adjust **SUPPRESSION** switch to get a stable non-flashing display. A negative sign in a flashing display indicates that the conductivity signal is out of range in the negative direction and the suppression value should be decreased. A positive sign in a flashing display indicates a positive overrange and the suppression value should be increased. A stable display with a positive sign gives a direct reading of 2 X the conductivity ratio value.
- (a) Set function switch to **STANDBY**;
 - (b) Remove sample bottle;
 - (c) Wipe pick-up tube;
 - (d) Flush conductivity cell; and
 - (e) Switch off pumps.
- Step 7. Proceed with next sample by repeating procedure from Step 1, or proceed as follows if leaving instrument to idle for more than a few hours or shutting-down:
- (a) Install bottle of distilled water in place of sample bottle;
 - (b) Turn pumps on and flush approximately 400 ml through conductivity cell until readout, with **READ** selected and **SUPPRESSION** switch set to 0.0 is less than 0 050;
 - (c) Turn pumps off, leaving distilled water in conductivity cell, and return **FUNCTION** setting to **STANDBY**; or
 - (d) Flush cell completely and drain tank via tank **DRAIN/FILL** valve if storing instrument.

6.3. CONVERTING INSTRUMENT READING TO SALINITY

The instrument reading is displayed in terms of

$$2 \times \text{CONDUCTIVITY RATIO OR } 2R_t$$

of the sample to the sea-water standard. Convert the instrument reading to salinity value by using one of the two following methods:

- (1) Utilize the Unesco technical papers in marine science, No. 39 titled "International oceanographic tables, Vol.3."

NOTE: Copies may be obtained from:

**Division of Marine Sciences
Unesco
Place de Fontenoy
75700 Paris, France**

or from most oceanographic libraries or institutes.

- (2) Calculate salinity using the following equation:

$$S(\text{PSU}) = a_0 + a_1 R_t^{1/2} + a_2 R_t + a_3 R_t^{3/2} + a_4 R_t^2 + a_5 R_t^{5/2} + \Delta S$$

$$\Delta S = \frac{(t-15)}{1+k(t-15)} \left(b_0 + b_1 R_t^{1/2} + b_2 R_t + b_3 R_t^{3/2} + b_4 R_t^2 + b_5 R_t^{5/2} \right)$$

where:

$a_0 =$	0.0080	$b_0 =$	0.0005
$a_1 =$	-0.1692	$b_1 =$	-0.0056
$a_2 =$	25.3851	$b_2 =$	-0.0066
$a_3 =$	14.0941	$b_3 =$	-0.0375
$a_4 =$	-7.0261	$b_4 =$	0.0636
$a_5 =$	2.7081	$b_5 =$	-0.0144

$\Sigma a_i =$	35.0000	$\Sigma b_i =$	0.0000
----------------	---------	----------------	--------

t = the bath temperature in °C

$$k = 0.0162$$

This calculation is valid over the salinity range from 2 PSU to 42 PSU.

These tables and the equation are based on the definition and the algorithm of practical salinity formulated and adopted by the Unesco/ICES/SCOR/IAPSO Joint Panel on Oceanographic Tables and Standards, Sidney, B.C., Canada, 1980.

6.4. STANDARD OPERATING PRACTICES

These practices are recommended to ensure high standards of operation and thus optimize instrument service life and/or improve instrument performance.

- (a) When "flushing" - ensure FUNCTION switch is on STANDBY setting and not turned back to READ until cell fills. Otherwise, electronics overloading may occur causing a small temporary read offset requiring several minutes recovery time.
- (b) When not using pumps - switch off to minimize pump maintenance and, if required, to conserve sample water.

6.5. MEASURING FOR OPTIMAL ACCURACY

6.5.1. INSTRUMENT ACCURACY

The guaranteed accuracy (± 0.002 PSU) of this instrument makes allowance for some variations in the ambient temperature as is readily achieved when the basic standardization and operating procedures are followed. Performance to ± 0.001 PSU or less can be achieved with controlled conditions of the operating environment, the careful handling of samples and refined instrument operating procedures.

6.5.2. PROCEDURAL REFINEMENTS

The following recommendations are provided as a guideline to the operator requiring repeatable results to better than the instrument rated accuracy:

- (a) Operate the instrument with the bath temperature set 1°C or 2°C above ambient temperature. (The closer to ambient temperature, the better.) Temperature control of the laboratory may be required if there are large time/temperature variations.
- (b) Allow at least 24 hours for the bath to stabilize.
- (c) Let the sample come to ambient temperature before using it (for nominal accuracy, a lower flow rate will accommodate a wider temperature difference).
- (d) If two or more instruments are to be standardized for agreement with each other, fill all the cells with 35 PSU water before standardizing so that fewer flushes are needed and that the same bottle of standard sea-water will suffice to standardize all units.
- (e) In general, once a cell has stabilized to the correct value, start reading after 5 seconds and visually average the readings for 10 to 15 seconds. The final average reading should repeat for three consecutive flushes to within ± 2 digits (i.e. ± 0.0004 PSU at a salinity of 35 PSU).

- (f) Average instrument readings for 15 to 30 seconds to smooth out the variations caused by small changes in the bath temperature (± 0.5 mK is equivalent to ± 2 digits).
- (g) When leaving the instrument for more than an hour between readings, the cell should be filled with distilled water and the pumps turned off. If the instrument sits idle for prolonged periods, leave distilled water in the cell and shut off the power. When the power is restored, fill the cell with salt water.
- (h) The **STANDBY** number is used to determine electronics drift from standardization. It cannot be used to determine standardization stability since it is not affected by bath temperature or bath temperature variations. If in doubt restandardize.
- (i) Typical flushing volumes required to measure a sample of 35 PSU salinity water **STARTING WITH DISTILLED WATER IN THE CELL** (the most rigorous condition) are as follows:
 - within 100 ppm after 3 flushes.
 - within 10 ppm after 7 flushes.
 - within 3 ppm after 8 flushes.
 - within 1 ppm after 10 flushes.
 - confirmation of reading within 1 ppm after 14 flushes.

These numbers are typical assuming approximately 15 ml per flush and read cycle. If the salinity change is less than 5 PSU, typically 50 ml or three or four flushes are required to be within a salinity of 0.003 PSU. Note that the final answer is not determined by an exact number of flushes but repeatability of the readings. Remember that 1 count of the last digit on the display (± 1 digit) is approximately 0.0002 PSU at 35 PSU.

6.6. SAMPLE HANDLING FOR OPTIMAL ACCURACY

The following methods are suggested to obtain the best possible measuring results.

6.6.1. METHOD TO REMOVE SAMPLE BOTTLE AND LEAVE CELL FULL

- (a) When cell is full, switch pumps off.
- (b) Turn **FLOW RATE** knob completely counter-clockwise.
- (c) Remove sample bottle. Water will remain in the cell and in the sample fill tube.

6.6.2. METHOD TO REMOVE WATER FROM PICKUP TUBE PRIOR TO MEASURING NEW SAMPLE

NOTE: This method prevents drops of water from contaminating new sample.

- (a) Assuming there is water in the cell and in the pickup tube, and that the pumps and flow are off, turn the flow on.
- (b) Switch the pumps on.
- (c) Insert the end of the pickup tube into the pickup tube holder.
- (d) Cover **FLUSH** vent, then release.
- (e) Observe water flowing out of the pickup tube toward the cell.
- (f) When water reaches the metal portion of the pickup tube, lower the tube and wipe the end with a tissue. Dispose of the tissue after use. This removes salt from the tube which may have been picked up from the operator's fingers.
- (g) Put new sample in place and proceed with reading. Flush 3 times before taking first reading.

7. INSTALLATION AND OPERATING INSTRUCTIONS FOR OPTIONAL BCD OUTPUT

7.1. GENERAL

The BCD output provides complete digital output of the display reading and bottle number dialed, as well as a "Write Enable" signal. All outputs are fully buffered, TTL compatible and use positive logic. A double shielded 50 pin Male to 50 pin Female cable 5 feet long, is recommended for use with this output. The double shielded cable is available as Guildline part number 996-23200.

7.2. BCD CONNECTOR PIN CODE

The BCD output uses a 50-pin connector on the instrument back panel. Connector pinouts are shown in Figure 7.1. The BCD logic is defined in Table 7.1 using as an example a typical instrument reading:

7890 1.2+3456

The first group of four digits is the bottle identification number; the second of six digits, the display output.

The WRITE ENABLE pulse occurring every 250 milliseconds approximately appears on Pin 21. The signal references are on Pins 29 and 30. Control outputs from the DATA LOG pushbutton use Pins 31, 32 and 33 as follows:

Pushbutton not pressed - Pins 32 and 33 shorted
Pushbutton pressed - Pins 32 and 31 shorted

Pins 7, 9, 28 and 42 are not used (N.U.).

7.3. OPERATING PROCEDURE

- (a) Enter bottle identification number on thumbwheel switch each time new sample is installed.
- (b) Press **DATA LOG** pushbutton momentarily when sample measurement is completed and display indicates final reading.

FUNCTION	PIN NUMBER				BCD CODING				
	3	2	1	0	EXAMPLE READING	LOGIC			
Bottle No. Digit 4 (LSD)	13	12	11	10	0	0	0	0	0
Digit 3 (3rd MSD)	17	16	15	14	9	1	0	0	1
Digit 2 (2nd MSD)	46	45	44	43	8	1	0	0	0
Digit 1 (MSD)	50	49	48	47	7	0	1	1	1
Display Digit 6 (LSD)	37	36	34	35	6	0	1	1	0
Digit 5 (5th MSD)	41	38	39	40	5	0	1	0	1
Digit 4 (4th MSD)	24	25	26	27	4	0	1	0	0
Digit 3 (3rd MSD)	18	19	22	20	3	0	0	1	1
Sign	-	-	-	23	+	-	-	-	0
Display Digit 2 (2nd MSD)	4	3	5	6	2	0	0	1	0
Decimal	-	-	-	8	.	-	-	-	0
Display Digit 1 (MSD)	-	-	2	1	1	-	-	0	1

Table 7-1: BCD Connector Pin Coding

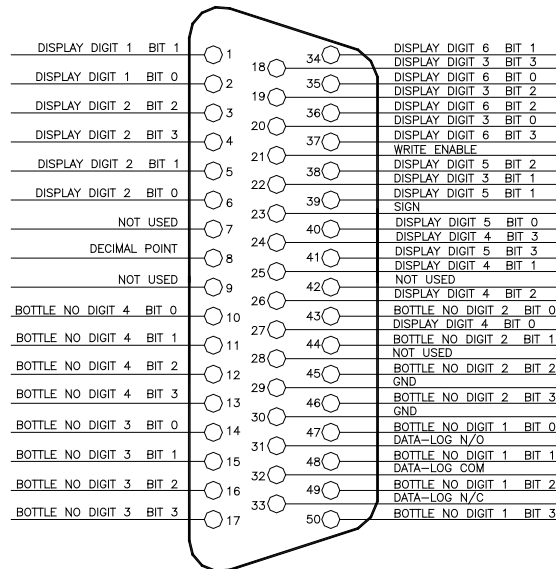

CONNECTOR AS VIEWED FROM BACK OF AUTOSAL

Figure 7.1: Connector Pinouts

8. GENERAL TECHNICAL INFORMATION

8.1. INSTRUMENT COMPONENT LOCATION

The 8400B is a combination of electronics, mechanics, plumbing and air piping. The whole is a complex instrument with many separate devices mounted, as required, in different sections of the instrument. The following sections describe the physical layout of the instrument.

8.1.1. CABINET

The instrument chassis is mounted in a standard 19" rack instrument cabinet. The chassis pulls out on four rack slides, and can be removed completely.

8.1.2. CHASSIS

A rear view of the instrument chassis is shown in figure 8.1 "Chassis Back". The rack slides are indicated. The front panel interior is shown in detail in figure 8.2 "Front Panel". A close-up view of the top panel is shown in figure 8.3 "Top Panel".

The front panel is attached to the chassis with a piano hinge.

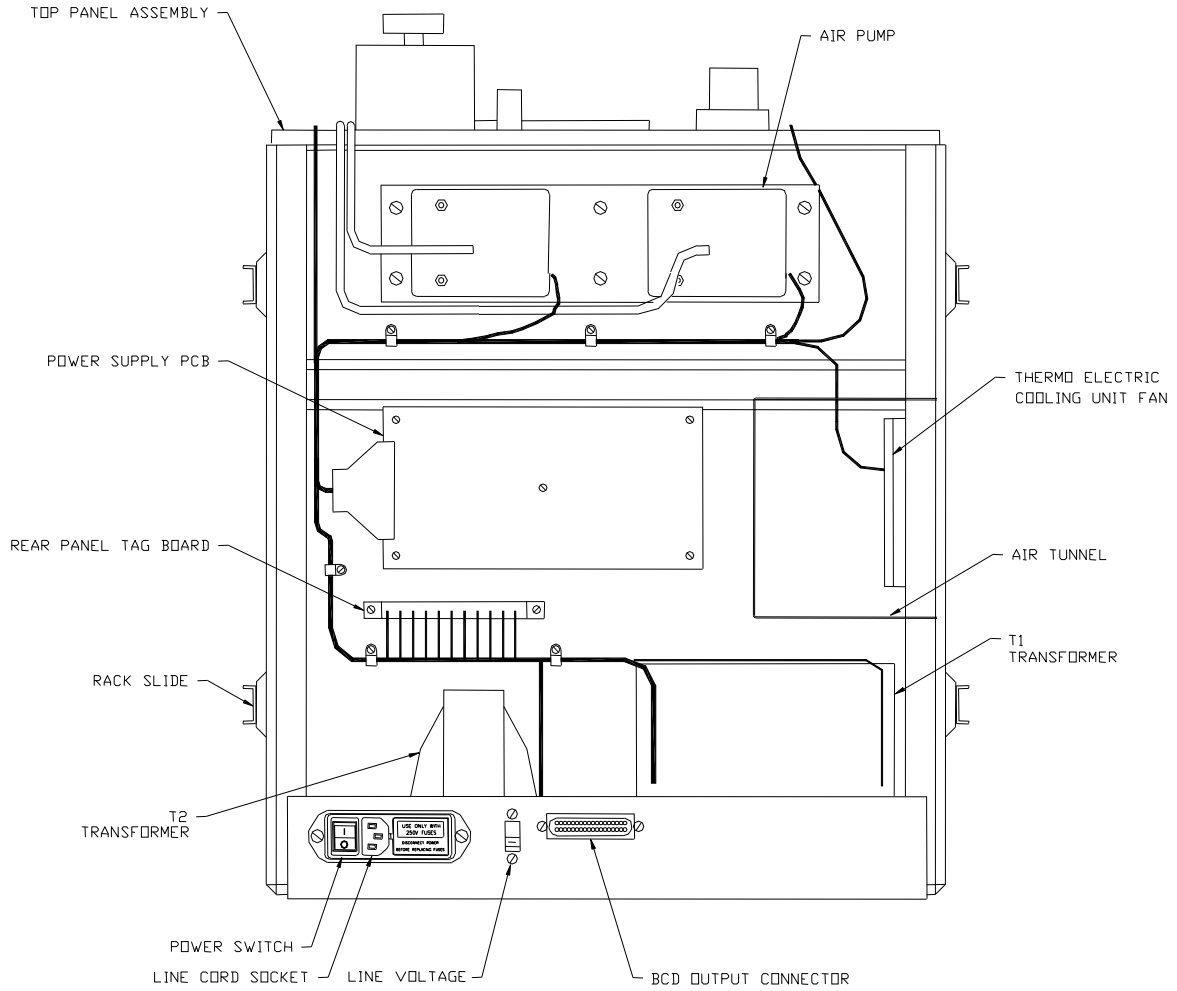

Figure 8.1: Chassis Back

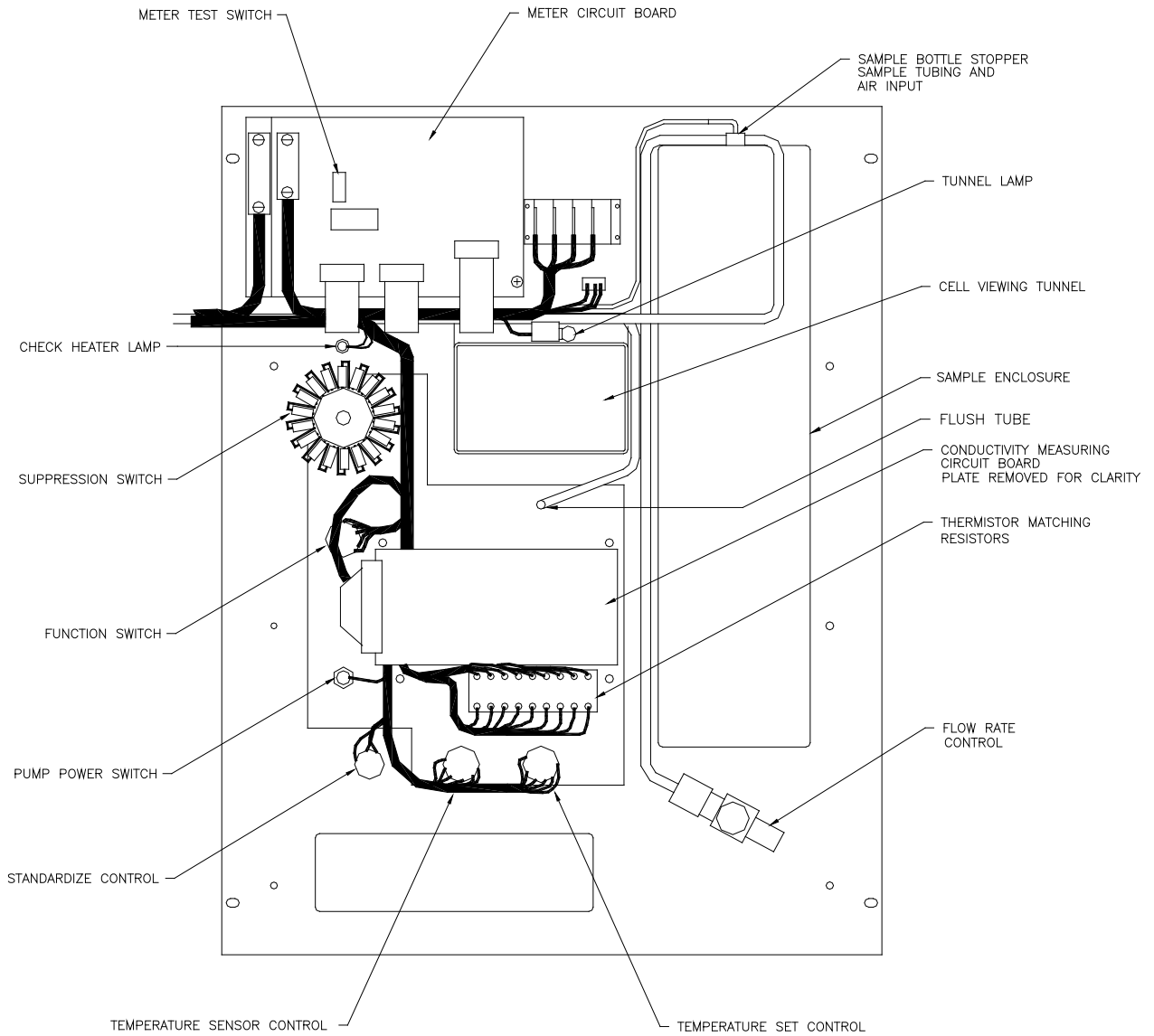

Figure 8.2: Front Panel

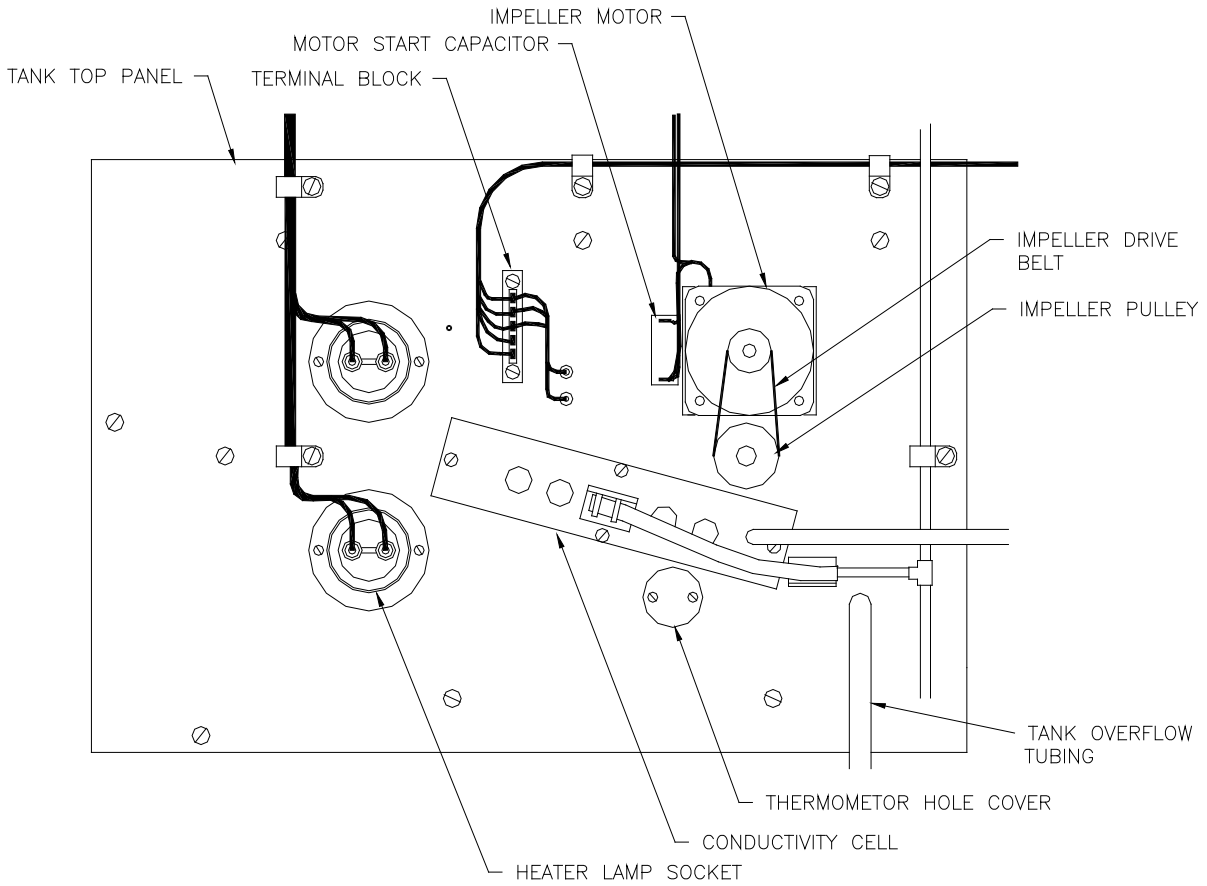

Figure 8.3: Top Panel

9. THEORY OF OPERATION

9.1. GENERAL

The measurement theory of the Autosol is explained in Section 3.1. The following sections explain the operation of the electronic circuitry.

9.2. POWER SUPPLY

The power supply circuitry is contained on the Power Supply and Heater Control circuit board schematic 18962.01.04. The power supply provides regulated 5 volts D.C. for the meter assembly, and ± 15 volts DC for the meter, and unregulated ± 15 volts for the conductivity circuits. Referring to the Power Supply and Heater Control Circuit Board schematic and assembly, VR101 provides +15 volt and -15 volt regulation. VR102 is the 5 volt regulator. All the other power supply components are also mounted on the board except the power transformer T1 and T2 which are mounted on the rear of the instrument chassis.

9.3. TEMPERATURE CONTROL CIRCUIT

The temperature control sub-system is in the form of a bridge network where one half of the bridge is formed by the parallel arrangement of two thermistors and their corresponding matching resistors. The thermistor matching resistors are selected to provide a bridge balance within ± 20 mK of the selected temperature and are mounted on the front panel assembly along with the temperature setpoint switch and sensor select switch. The thermistors are mounted on the top of the tank assembly.

Continuous cooling of the tank is applied through a thermoelectric cooling module. This module forms part of the temperature control circuit but is powered on permanently to provide cooling at a constant rate.

9.4. CONDUCTIVITY MEASURING CIRCUIT

The chopper circuit provides complimentary chopping or reversing signals, and non-overlapping sampling signals.

9.5. METER ASSEMBLY

The meter assembly converts the conductivity signal into a digital number, and drives the front panel display and the BCD* circuit if equipped. The meter assembly is made up of two circuit boards, the meter circuit board and the display circuit board.

9.5.1. METER CIRCUIT

The meter circuit consists of a 4½ digit digital voltmeter chip set, clocks and drive and decoding.

9.5.2. DISPLAY CIRCUIT

The display circuit contains logic to decode the settings of the front panel switches for display, and light emitting diode displays.

10. MAINTENANCE

10.1. INTRODUCTION

The maintenance procedures described in this section can be done with the instrument installed in the laboratory.

Other than for external cleaning, the prescribed maintenance requires that the front panel be opened or chassis withdrawn, or rear panel be removed.

WARNING

Disconnect power cord before attempting any maintenance inside cabinet except as required for operational tests.

10.2. GENERAL INSPECTION

Periodically examine instrument interior for loose tubing clamps, loose wiring connectors or connections, or spills. Include bath temperature control check to ensure the two heater lamps work. When instrument is used on a ship, this check should be made daily.

10.3. GENERAL CLEANING

Wipe instrument case with soft lint-free wiper, using mild detergent to remove grease. Due to the corrosiveness of sample water, wipe spillage and neutralize corrosive surfaces as soon as spillage is detected.

10.4. OPENING THE CABINET

The opening is a two-stage operation; one to withdraw the chassis and one to hinge out the front panel. This allows access to interior for inspection, testing and certain parts replacement.

CAUTION

Be careful when opening front panel that chassis does not roll out unexpectedly. If intending to withdraw chassis ensure there is sufficient bench space in front and that its weight is supported at all times.

Open front panel and withdraw chassis as follows:

- STEP 1.** Remove four front panel screws.
- STEP 2.** Remove three screws beside bottle holder.
- STEP 3.** Carefully swing open front panel.

STEP 4. Withdraw the chassis as far as necessary, do not remove completely. Support with suitable wooden block.

10.5. BATH TEMPERATURE VERIFICATION TEST

WARNING

The following tests are done with the chassis exposed and the power turned on. There is accessible line voltage AC wiring on the top, front and rear panels. Extreme care must be exercised when working on the inside of this instrument when the instrument is connected to line voltage, especially when in a salt water environment. Lethal shock hazards may be encountered through careless procedures.

STEP 1. Open the cabinet and withdraw chassis as per Section 10.4.

STEP 2. Remove thermometer hole cover located in front of conductivity cell assembly, by removing two screws in cover.

STEP 3. Insert platinum resistance thermometer through exposed hole and into bath to verify bath temperature accuracy and stability. There is a holder inside the bath to secure the thermometer.

STEP 4. Turn on the instrument. If digital display is erratic or there is temperature drift check impeller drive belt for slippage. Clean pulleys and replace belt if necessary.

STEP 5. Remove thermometer and re-install hole cover.

STEP 6. Ensure fans are operating and air filter is clean.

10.6. DISPLAY METER TEST

STEP 1. Turn instrument on with **POWER** switch.

STEP 2. Turn **FUNCTION** switch to **ZERO**. Ensure display reads 0.0 0000 ± 2 digits.

STEP 3. Turn **FUNCTION** switch to **READ**. Step **SUPPRESSION** switch throughout its range. Observe two left hand digits vary from 0.0 to 2.2.

STEP 4. Turn **FUNCTION** switch to **STANDBY**. Observe two left hand digits indicate bath temperature setting.

STEP 5. Return **FUNCTION** switch to **ZERO**.

STEP 6. Open front panel. (Section 10.4).

- STEP 7.** Depress and hold meter test switch S301 mounted on inside front panel behind display. The display should read 0.0 2000 \pm 2 digits. Release S301.
- STEP 8.** If the display is not within \pm 2 digits of 0.0 2000 with S301 depressed, refer to 11.4.3. Step 3.

10.7. HEATER LAMP REPLACEMENT

- STEP 1.** Switch power off instrument and remove line cord. Withdraw chassis and open front panel as per Section 10.4.
- STEP 2.** Disconnect lamp socket wires from sliders.
- STEP 3.** Unscrew pigtail clamp ring and carefully pull out lamp socket.
- STEP 4.** Unscrew old bulb from socket.
- STEP 5.** Smear small amount of marine grease inside the lamp socket and O-ring gasket.
- STEP 6.** Slide O-ring gasket on to base of bulb. Screw bulb into socket.
- STEP 7.** Carefully re-insert lamp in its hole, tighten the retaining screws and reconnect lamp socket sliders.

10.8. CONDUCTIVITY CELL REMOVAL

Perform the following steps to remove the conductivity cell for cleaning, inspection or replacement. The conductivity cell should be replaced every 5 to 7 years to ensure stable readings. Cleaning the cell is required when an erratic digital display persists when all controls are set for normal operation, especially during standardization. The cause is usually from a contaminating film such as oil, algae etc. Proceed as follows:

- STEP 1.** Withdraw chassis from cabinet (Section 10.4).
- STEP 2.** As seen from front of instrument, disconnect drain tube on right hand side of the cell from reducer coupling.
- STEP 3.** Remove four small screws securing cell assembly to tank cover.
- STEP 4.** Lift cell right hand end first so drain tube clears openings in top panel.
- STEP 5.** Remove cell drain tube from plastic coupling. Do not remove coupling.
- STEP 6.** Remove cell fill tube from its coupling inside the tank.

- STEP 7.** Remove plastic bushing from inside cell with small blunt nose pliers. (An alternate method is to press bushing out with an appropriate size punch. Replace bushing if damaged during removal.)
- STEP 8.** Cut straps holding cell to support pillars.
- STEP 9.** Hold cell assembly under hot water for one or two minutes.
- STEP 10.** Gently but firmly ease off four plastic tubes with electrode assemblies from cell arms.
- STEP 11.** Clean cell with bottle brush using hot water and mild detergent. Rinse thoroughly with distilled water.
- STEP 12.** Connect cell to plastic tubes and support pillars.
- STEP 13.** Connect fill end of cell to a water tap using suitable tube. Flush cell with running water. Pinch drain tube, creating sufficient back pressure to flush water through all four arms and air tubes.
- STEP 14.** Disconnect from water supply. Blow air through air flush tube to clear water from cell and air tubes.
- STEP 15.** Carefully re-connect all tubing. Carefully reinstall cell assembly to its position in top panel.

10.9. PUMP SERVICING

Work required consists of:

- (a) Lubrication of pump bearings using good quality SAE 20 engine oil.

NOTE: Never use fuel oils, utility oils, rust preventatives or like preparations.

- (b) Replacement of air filter.

10.9.1. SERVICE INSTRUCTIONS

Proceed as Follows:

WARNING

Line voltage is present on pump cover, and also inside pumps. Disconnect Instrument from line voltage before performing this servicing.

- STEP 1.** Disconnect pump wires and air hoses.

- STEP 2.** Remove the six screws which hold the assembly to the chassis back.

- STEP 3.** Turn the pump slide upside down. Line up the hole in the fan with the hole in the motor bearing.
- STEP 4.** Put 3 or 4 drops of SAE 20 oil in the lower bearing. Allow a few minutes for the oil to soak in.
- STEP 5.** Put one drop of SAE 20 oil on the following: on top of the main bearing; in the hole indicated by arrow on large pulley; on the piston washer; on top motor bearing through hole under the small pulley.
- STEP 6.** Wipe off any excess oil. Make certain the belt is kept clean and free from oil.
- STEP 7.** Replace the air filter.

CAUTION

Never change the air filter while the pump is running or dust may enter the valves. Never use a pump without a filter.

- STEP 8.** Replace and reconnect pump assembly in reverse order.

11. SERVICING AND CALIBRATION

11.1. GENERAL

This section supplements Section 10. The frequent user checks and maintenance procedures are listed in that section. This section contains further maintenance and servicing details, and a complete calibration procedure should tests indicate that recalibration is necessary.

11.2. MAINTENANCE SCHEDULE

Table 11.1 contains a recommended maintenance schedule. This schedule is provided as a guide only, and individual users will find that the need for various checks will change depending on use and location of the instrument.

Table 11.2 shows how often the various operational checks as outlined in the operating manual should be made.

11.3. SERVICE NOTES

The following procedures may be referred to in the troubleshooting section, which may be necessary for servicing.

11.3.1. CLEANING FLUSHING MANIFOLD/TUBES

If the small air flushing tubes on the conductivity cell become blocked with salt deposit, remove the cell as outlined in Section 10.8 including disconnecting the short large diameter tube attached to the cell support arm from the long smaller diameter tubing from the air pump. Force warm soapy water down the large tube into the small flushing tubes to clean them. Then rinse the tubing and blow dry. Reassemble the cell as in Section 10.8.

ITEM	MAINTENANCE PERIOD	
	LABORATORY USE	SHIPBOARD USE
1. General Interior Inspection	1 month	1 week
2. Bath Temperature Verification	1 month	2 weeks
3. Display Meter Test	2 months	1 month
4. Pumping Service	300 hrs use	100 hrs use

Table 11-1: Maintenance Schedule

ITEM	CHECK PERIOD
1. Function Check	during use
2. Bath Temperature Control Check	daily
3. Zero Reference Check	during use
4. Standardization	24 hrs for .002 PSU

Table 11-2: Operating Checks Schedule

11.3.2. CHECKING THERMOELECTRIC COOLING UNIT

A simple check is to place your hand in front of the cutout on the left hand side inside the front panel. The air expelled should be warm. If thermoelectric cooling unit appears defective, we recommend returning the instrument to the factory since changing it requires removing the tank from the instrument frame.

11.3.3. CHECKING IMPELLER

If the impeller is not stirring, do the following checks. Withdraw the chassis from cabinet, and check impeller drive system. When power switch is on, the impeller motor should be turning. The impeller pulley should turn easily by hand when the power is off. The impeller drive belt should fit snugly over the impeller and motor pulleys without slipping.

11.3.4. CHECKING HEATER LAMPS

When the Temperature selector switch is turned to a temperature well above the bath temperature, the heater lamps should both come on fully. When the selector switch is turned to a temperature well below the bath temperature, the heater lamps should go dark. If only one lamp lights the other one is almost certainly defective and should be replaced.

11.3.5. REMOVING TOP PANEL

(NOT NECESSARY TO REPLACE LIGHT BULBS)

- Step 1.** Turn off power, disconnect line cord, and remove instrument chassis from cabinet.
- Step 2.** Disconnect cell connector, Lamp and thermistor wiring as required.
- Step 3.** Disconnect teflon Sample Tube from heat exchanger tube top (see Top Panel and Top Panel Assembly and Plumbing drawings).
- Step 4.** Disconnect Cell Drain Tubing.
- Step 5.** Disconnect tubing from airline to flushing manifold.
- Step 6.** Remove 8 tank top securing screws from edges of tank top.
- Step 7.** Gently pry up one edge of the top panel. It is sealed by a greased gasket which is fairly sticky.
- Step 8.** When the seal is broken, lift the top panel straight up carefully so as not to damage the impeller, heater lamps or thermistors.
- Step 9.** Set the top panel down on an edge. DO NOT rest it on, or apply pressure to, the thermistors which are fragile.

11.3.6. REMOVING TANK

It is recommended that this operation is done at the factory.

- Step 1.** Drain Tank.
- Step 2.** Remove top panel.
- Step 3.** Remove thermoelectric cooling unit wires from wiring harness and disconnect.
- Step 4.** Remove tank drain hose from valve on front panel.
- Step 5.** Remove 4 tank holding screws and nuts from top lip of tank.
- Step 6.** Pull tank straight up, ensuring thermoelectric cooling unit heatsink does not snag on chassis or insulation.

11.4. AUTOSAL CALIBRATION

The following subsections contain a step by step procedure for testing the electronic performance of the 8400B and calibrating the instrument. This procedure can be used to check operation, repair circuitry or recalibrate.

The test equipment required for circuit checking is standard electronic instrumentation

- 4½ digit digital voltmeter
- dual trace oscilloscope
- frequency counter
- digital thermometer (Guildline 9540)
- miscellaneous hardware

The additional equipment required for calibration is:

- .01% precision decade resistance box
- IAPSO Approved Standard Seawater.

CAUTION

This procedure should only be attempted by qualified electronic personnel.

WARNING: SHOCK HAZARD

Line voltage is present on front, back and top panels when Autosal is connected to line, even when NOT turned on.

11.4.1. POWER SUPPLY CALIBRATION

- Step 1.** Check the line voltage select switch is in the proper position. Check the line fuse (installed and correct value), plug into power outlet.
- Step 2.** Ensure that heater and power supply PCB (18962) is installed and all other PCB's are disconnected.
- Step 3.** Turn the power on and check that the thermoelectric cooling fan, the back panel fan and the tank stirrer operate.
- Step 4.** Turn the pumps on and check that they both operate, turn off pumps and power.
- Step 5.** Connect scope to TP1. Ground to TP3. The reading should be approx. 15 V DC with less than ± 200 mV.
- Step 6.** Connect scope to TP2. The reading should be approx. -15 V DC ± 200 mV.
- Step 7.** Connect scope to TP4. Ground to TP5. The reading should be approx. 5 V DC ± 200 mV.
- Step 8.** Check that with the temp set switch at 18°C BOTH heater lamps go dark.
- Step 9.** Check that with the temp set switch at 33°C BOTH heater lamps light.

*Providing tank temperature is greater than 18°C when measure taken and less than 33°C.

11.4.2. CONDUCTIVITY PCB CHECK

- Step 1.** Turn power OFF.
- Step 2.** Turn Function Switch to zero.

- Step 3a.** Switch power ON.
- Step 3b.** Use the positive lead of C208 as the ground reference for the following steps unless otherwise stated.
- Step 4.** Check +15 V DC (at R222 right lead), -15 V DC (at R241 left lead), +7.5 V DC (at R222 left lead), -7.5 V DC (at R241 right lead).
+15 V supply can be adjusted with R211, -15 V supply can be adjusted with R212. 15 V supplies should be within ± 0.01 V and 7.5 V supplies should be within the range 7.5 V to 8.5 V.
- Step 5.** Connect scope to TP14. Adjust R257 for a frequency of approximately 150 Hz for 60 Hz line power operation.
- NOTE: If 50 Hz line power operation is required the oscillator frequency may have to be changed to approximately 175 Hz to eliminate beating with the line which causes the instrument to be slightly unstable. Changing the frequency may be done by adjusting R257.**
- Step 6.** Connect a dual beam scope to TP13 and TP14. Check that TP13 overlaps TP14 by at least 100 μ s (See Figure 9.1).
- Step 7.** Connect a dual beam scope to TP11 and TP12. Waveforms should appear in same phasing to TP13 and TP14 as shown on Figure 9.1.
- Step 8.** Connect DVM to TP6. Should be +10.00 V DC ± 0.03 V DC.
- Step 9.** Connect DVM to TP10. Should be -10.00 V DC ± 0.03 V DC.
- Step 10.** Connect scope to TP5. Should be 1.82 ± 0.02 volt square wave.
- Step 11.** Connect scope to TP7. Should be $< \pm 5$ mV.
- Step 12.** Connect scope to TP2. Should be $< \pm 0.2$ mV.
- Step 13.** Connect scope to TP1. Should be 0.73 ± 0.01 volt square wave.
- Step 14.** Connect scope to TP4 w.r.t. TP3. Turn Function Switch to ZERO position. Should be $< \pm 5$ mV.
- Step 15.** Connect scope to TP4 w.r.t. TP3. Set temperature to 24°C. Switch function switch to **STANDBY** position. Should be 0.75 ± 0.03 volt peak to peak square wave. Turn Function Switch to **ZERO**.

- Step 16.** Connect scope to TP9. Should be $<\pm 5$ mV.
- Step 17.** Set Function Switch to **STANDBY**. TP9 should be less than 1 volts square wave.
- Step 18.** Connect scope to TP8. Should be between 0 V DC and -5 V DC.

11.4.3. METER CALIBRATION

- Step 1.** With Function switch to zero position meter display should read approximately zero. The offset (if any) is from the conductivity board and will disappear after conductivity board is calibrated in Section 3.4.4 step 1.
- Step 2.** Connect frequency counter to TP11 (on Meter PCB 16504) and measure clock frequency. Frequency should be 120 kHz ± 5 kHz for 60 Hz line frequency, or 125 kHz ± 5 kHz for 50 Hz line frequency. Adjust R306 if necessary.
- Step 3.** Depress and hold test switch (S301) on meter circuit board. (This switch disconnects reference and signal inputs from conductivity board and connects meter reference and signal inputs to an on board voltage. By resistive division signal voltage is 20% of reference voltage). The display should read XX2000 ± 0002 digits with instability of ± 0001 digits. Adjust R309 if necessary to obtain correct reading. Release Test switch.

11.4.4. MATCHING AND BALANCING

NOTE: The following steps for balance, zero and gain adjustments assume that the proper matching resistor R203 has been installed for the conductivity cell in use.

- Step 1.** Connect a 0.1 Ω /step decade box in place of the conductivity cell. Connect a 500 Ω resistor, 4.7 μ f capacitor and two switches shown in Figure 11.1 in series with the High Current (C1) lead to the decade box. Set the decade box for 500 Ω , close S1 and open S2. Turn the Autoscal Function Switch to READ and set the Suppression Switch for a reading of less than XX+9999.

Open S1 and adjust R213 on the Conductivity PCB 18961 until no change is indicated by the display when the 470 Ω resistor is switched in and out with S1. Adjust to within ± 1 digit. This ensures that U205A and U205D are DC balanced as a differential amplifier.

Close S2 thereby switching in the 4.7 μF capacitor across the 470 Ω resistor.

Adjust R214 until no change is indicated on the display when S1 is opened and closed. This ensures that U205A and U205D are AC balanced as a differential amplifier.

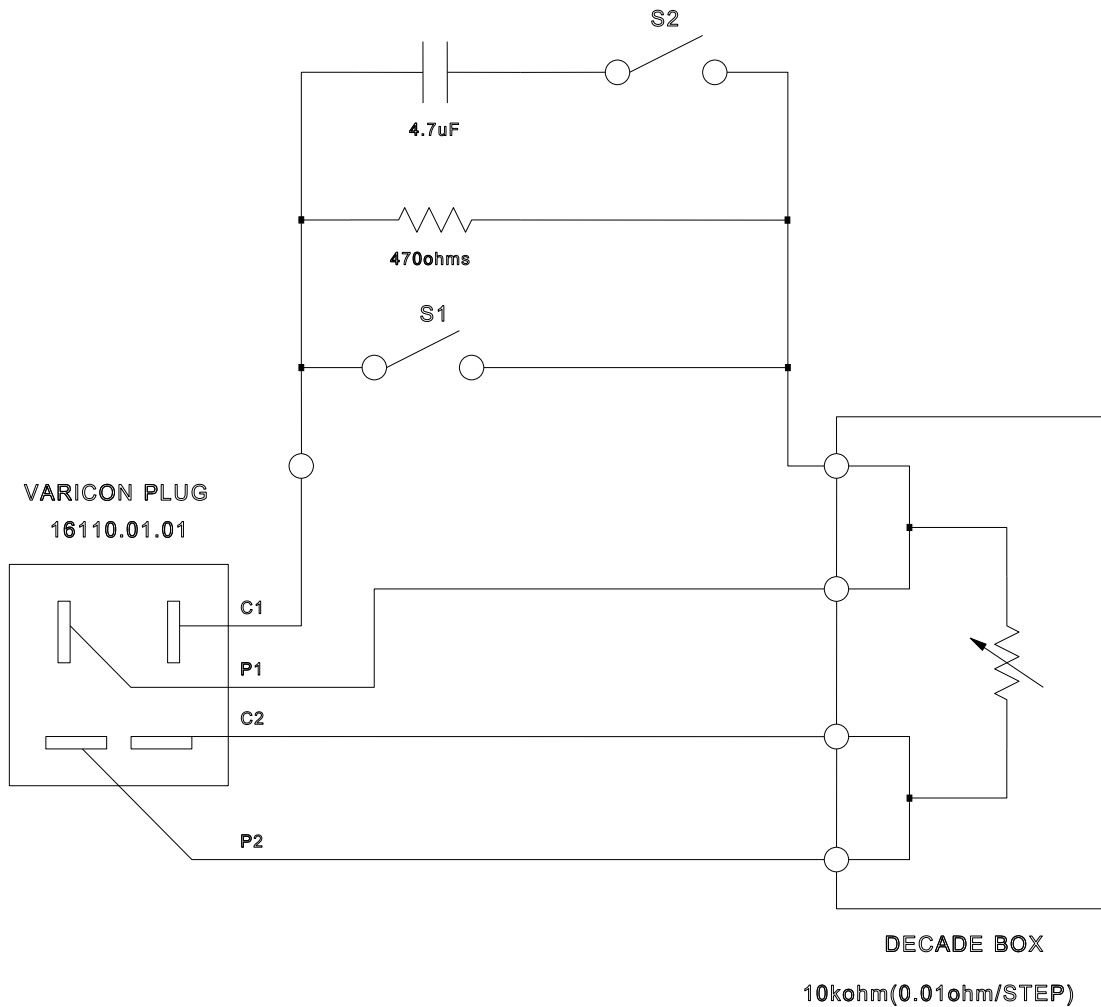

Figure 11.1: Conductivity Cell Simulator

- Step 2. Close S1. Turn unit function switch to zero and adjust R238 for a zero display.
- Step 3. (a) To adjust gain of amplifier, set Temp switch to 33°C. Set suppression switch to 22, function switch to Read, and Standardize Dial to 5.000. Dial the resistance box for a reading on the display of exactly 2.2 - 0250. It may be necessary to adjust the Standardize Dial slightly. Approximate values of the decade box setting required are given in Table 11.3. Turn suppression switch to step 21 and note reading on display. Adjust R237 for a reading of 2.1 + 9750. (A change of 10 000 ±1 digit).*
- (b) Turn suppression switch to 0.1, reset decade box until the display reads 0.1 - 0250 and check again. 0.0 setting for 0.0 + 9750.
- *If the gain is too far out of adjustment, it may be necessary to adjust the resistance box until the display reads more negative than 2.2 - 0250.
- Step 4. Set suppression switch at 22. Replace cell with decade box. Set box to get a display of 2.2 - 00XX record. Decrease suppression switch setting to 21 and record reading. The change in reading should be 10,000 digits. Repeat for all suppression steps. The approximate simulation resistances are shown in Table 11.3. This checks the linearity of the suppression switch steps.
- Step 5. Replace decade box with cell. Connect sample bottle of tap water and check for leaks in plumbing, proper flushing and filling of conductivity cell and rate of flow (30 sec. max. per cycle). (30 ml/min.)
- Step 6. Turn temp. set switch to 18°C. Fill bath with water approximately 18°C and check for possible leaks or plumbing malfunction. Slow filling is essential to prevent leaking at seals when overflow condition is reached.
- Step 7. Allow the bath temp to stabilize and check temperature with 9540 Thermometer probe inserted through hole in tank top. Repeat this for TEMPERATURE SENSOR switch setting of 1, 2 and Normal. Allowable tolerance is ±20 mK.
- Step 8. Repeat Steps 6 for temperature 21°, 24°, 27°, 30° and 33°.
- Step 9. Using standard seawater (Wormley Water or equivalent) check STANDARDIZE control with bath temp. at 18°C, 27°C, and 33°C.

- Step 10. If STANDARDIZE control is out of range at all temperatures the cell matching resistor (SOT) will have to be redetermined by the following procedure.
- (a) Set bath to 27°C and let stabilize.
 - (b) Set Standardize control to 500.
 - (c) Remove SOT (R203 on Chopper and Conductivity Board) and substitute a 0.1 Ω /step decade box.
 - (d) Determine the 2 X Conductivity Ratio required for a bottle of Standard Seawater
 - (e) While running this bottle of Standard Seawater through the unit, adjust the decade box until the proper Conductivity Ratio is achieved. The decade box resistance is the value of the new cell matching resistor (SOT). Install a high stability resistor of this value and repeat step 8.

SUPPRESSION STEP	RESISTANCE *(decade box)
0	7.0 kΩ
1	3.5 kΩ
2	2.0 kΩ
3	1.5 kΩ
4	1.1 kΩ
5	.95 kΩ
6	.80 kΩ
7	.70 kΩ
8	.60 kΩ
9	.55 kΩ
10	.50 kΩ
11	.45 kΩ
12	.42 kΩ
13	.38 kΩ
14	.35 kΩ
15	.34 kΩ
16	.32 kΩ
17	.30 kΩ
18	.28 kΩ
19	.27 kΩ
20	.25 kΩ
21	.24 kΩ
22	.23 kΩ

*Actual value may differ by 10% or more.

Table 11-3: Simulation Resistances

12. TROUBLESHOOTING

12.1. GENERAL

This troubleshooting section outlines procedures for diagnosing and solving operating and accuracy problems which may be encountered when using the Autosal. The 8400B is a very precise measuring instrument and can produce such accurate readings that small errors in sample handling and instrument use can show up as significant reading errors or inconsistencies. Double check procedures before suspecting instrument error. Salt water is a powerful corrosive and fouling agent. The fine plumbing elements required to provide measuring accuracy are susceptible to deterioration due to salt fouling. If salt fouling is a constant problem, the maintenance period should be decreased, and handling procedure should be reviewed.

Table 12.1 covers the troubleshooting procedures. This list was compiled from customer feedback from the 8400 salinometer. We will be happy to receive further problems and solutions from customers to be included in subsequent revisions of this manual.

Equipment required for the troubleshooting steps is that outlined in the servicing section of this manual.

CAUTION

These tests require some expertise in electronic instrument servicing and should not be performed by untrained personnel, as irreparable damage may be caused by careless or incompetent handling, or the accuracy and stability of the instrument may be degraded.

WARNING

Some of these procedures require working on the exposed chassis of the instrument while it is connected to line voltage, and energized. LETHAL SHOCK HAZARDS can be encountered on rear, front and top panel wiring. Salt water and electricity do not mix.

PROBLEM	SYMPTOM	PROBABLE CAUSE
1. Standardization	STANDARDIZE dial must be continuously adjusted to maintain standardization	<p>Bath Temperature is not maintained constant.</p> <ul style="list-style-type: none"> - check Impeller motor, belt. - check heater lamps and temperature control circuit. - check thermoelectric cooling unit. - ambient temperature is outside bath control limits (4°C, -2°C). <p>Conductivity cell contamination.</p> <ul style="list-style-type: none"> - inspect and clean cell. <p>Leakage between sample circuit and bath.</p> <ul style="list-style-type: none"> - check cell and tubing connections, especially at heat exchanger and conductivity cell side arms and ends.
2. Standardization Drift	Requires single abrupt step changes in standardization adjustment.	<p>Bath Temperature Shift.</p> <ul style="list-style-type: none"> - checks as in step 1. - check thermistors, use Temperature Sensor control to see if control points differ. <p>Conductivity cell contamination</p> <ul style="list-style-type: none"> - check as in step 1. <p>Zero shift in circuitry.</p> <ul style="list-style-type: none"> - check zero, both with Function control and distilled water - discrepancy indicates zero shift - check and or recalibrate conductivity circuit board.

PROBLEM	SYMPTOM	PROBABLE CAUSE
3. Unstable Reading	Conductivity reading fluctuates excessively	<p>Salinity Gradients in sample</p> <ul style="list-style-type: none"> - ensure sample is well mixed. <p>Sample is too hot or cold</p> <ul style="list-style-type: none"> - sample temperature must be stabilized to bath temperature in heat exchanger - sample temperature should not exceed 5°C of bath temperature at full flow rate. <p>Sample flow rate too high.</p> <p>Temperature Drift.</p> <ul style="list-style-type: none"> - check temperature control circuit, and bath temperature. <p>Cell contamination - bubbles in cell arms</p> <ul style="list-style-type: none"> - check cell visually for contamination or improper arm filling, remove if necessary (see operating manual). <p>Ground path through sample exhaust.</p> <ul style="list-style-type: none"> - waste sample hose must not make contact with external devices such as waste buckets, water path must be broken. <p>Noisy Conductivity Circuit.</p> <ul style="list-style-type: none"> - check circuit boards for salt contamination or defective components. - external Radio Frequency (RF) or Electromagnetic Interference (EMI) sources present (with 3V/M source, noise will typically degrade to $\pm 0.2\%$ fullscale, or display reading ± 0.0500). - poor grounding of the instrument to the laboratory grounding system via the line cord ground pin. <p>Frequency beat of conductivity circuit chopper and/or meter clock with line frequency.</p> <ul style="list-style-type: none"> - check frequencies in calibration procedure. <p>Cell polarizing</p> <ul style="list-style-type: none"> - see step 5.

PROBLEM	SYMPTOM	PROBABLE CAUSE
4. No Heating	Heater Lamps off continuously	<p>Ambient temperature is too high. Sample temperature too high, flow rate too fast. Rear panel exhaust fan not working. Control Circuit malfunction.</p> <ul style="list-style-type: none"> - check heater lamps - check for power to heater lamps - heater control SCR may be defective.
5. Cell Polarizing	Bubbling or discoloration of one electrode	<p>Depolarizing circuit defective.</p> <ul style="list-style-type: none"> - check output of circuit - it should average to zero.
6. Flushing Malfunction	Cell arms not flushing or filling properly	<p>Air pumps defective</p> <ul style="list-style-type: none"> - see pump maintenance <p>Air lines broken/disconnected. Flushing manifold tubes blocked with salt buildup</p> <ul style="list-style-type: none"> - disconnect from air line and flush tubes with warm soap solution under pressure then air dry.
7. Sample not Flowing		<p>Heat exchanger blocked. Air pump defective. Air lines broken/disconnected. Sample bottle not sealed properly.</p>
8. Zero Shift	<p>Non zero display when in zero function position. Non zero display when distilled water sampled.</p>	<p>Amplifier has been saturated</p> <ul style="list-style-type: none"> - allow several minutes for circuitry to recover from overload. <p>Conductivity circuit amplifier offset.</p> <ul style="list-style-type: none"> - check circuit and calibrate if necessary. <p>Temperature shift. Reference voltage deteriorated. Analog to digital converter drifting (very unlikely due to auto zero mode.)</p>
9. Standby	Standby number has changed	<p>Conductivity circuit gain error or meter gain wrong.</p> <ul style="list-style-type: none"> - check meter test value; if this value has changed, adjust meter gain, otherwise check conductivity circuit.

PROBLEM	SYMPTOM	PROBABLE CAUSE
10. Unstable Temperature	Heater lamps on continuously	Bath Temperature set too high (maximum 4°C above ambient). Sample temperature too low. Control circuit malfunction - see step 4.
11. Bubbles in cell	Bubbles in cell which do not disappear after repeated flushings	Foreign matter on cell wall. - try flushing repeatedly with a wetting agent.

Table 12-1: Troubleshooting Guide

13. RECOMMENDED SPARE PARTS

13.1. STANDARD SPARE PARTS

These items are supplied with each new instrument, and available separately from the manufacturer as part no. 17657.01.02.

13.2. MAINTENANCE KIT

This parts kit contains a more comprehensive selection of spare parts which should provide all necessary repair parts for extended operation. It is recommended for shipboard operation. This kit is available from the manufacturer as model 84007.

13.3. PUMP MOTOR REPLACEMENT KIT

A replacement motor kit consisting of two air pumps complete with motor and mounting bracketry is available as model 84006.