



GUILDLINE
INSTRUMENTS

Operation Manual

For The

6623A-150

High Current Range Extender

www.guildline.com

NOTICE

The contents and information contained in this manual are proprietary to Guildline Instruments Limited. They are to be used only as a guide to the operation and maintenance of the equipment with which this manual was issued and may not be duplicated or transmitted by any means, either in whole or in part, without the written permission of Guildline Instruments Limited.

**OM6623A-150-M1-00
01 September 2021**

TABLE OF CONTENTS

1. INTRODUCTION	1-1
1.1. SCOPE.....	1-1
1.2. GENERAL DESCRIPTION.....	1-1
1.3. OVERVIEW	1-2
1.4. PRINCIPLE OF OPERATION	1-2
2. INSTALLATION	2-1
2.1. PRELIMINARIES	2-1
2.1.1. Unpacking.....	2-1
2.1.2. Power Voltage Selection	2-1
2.1.3. Fuse Replacement.....	2-2
2.1.4. Setup and Power On.....	2-3
2.2. INCOMING INSPECTION.....	2-4
2.3. 6623A-150 FRONT PANEL.....	2-9
2.3.1. Power	2-9
2.3.2. Fault	2-9
2.4. 6623A-150 REAR PANEL CONNECTORS AND CONTROLS	2-10
2.4.1. Line Input Connector	2-10
2.4.2. Resistor Under Test Terminals	2-10
2.4.3. Bridge Connector	2-10
2.4.4. Cautions	2-11
3. QUICK MEASUREMENT GUIDE	3-1
3.1. MEASUREMENT OPERATION GUIDE	3-1
3.1.1. Low Ohms Mode Resistance Measurement for all 6622A Models with the 6623A-150	3-2
3.1.2. Recommended Test Setup Limits for the 6623A-150.....	3-4
3.1.3. Checks and Precautions.....	3-4
3.1.4. Example Calculations.....	3-5
3.1.5. Test Current Cable Size.....	3-5
3.1.6. Use of Multiple Cable Connections.....	3-5
3.2. BRIDGEWORKS DATA ACQUISITION SOFTWARE	3-7
4. INSTRUMENT OPERATION	4-1
4.1. FRONT PANEL OPERATING PROCEDURE	4-1

5.	VERIFICATION AND CALIBRATION	5-1
5.1.	RATIO ACCURACY VERIFICATION.....	5-1
5.1.1.	Purpose	5-1
5.2.	TEST EQUIPMENT REQUIRED.....	5-1
5.3.	PROCEDURE.....	5-2
5.3.1.	PRELIMINARY MEASUREMENT OF THE 9230A-30A-0.1 SHUNT	5-2
5.3.2.	VERIFICATION OF THE x20-3A RATIO OF THE 6623A-150 RANGE EXTENDER	5-2
5.3.3.	VERIFICATION OF THE x100-15A RATIO OF THE 6623A-150 RANGE EXTENDER.....	5-4
5.3.4.	VERIFICATION OF THE x1000-150A RATIO OF THE 6623A-150 RANGE EXTENDER.....	5-6
6.	TROUBLESHOOTING, MAINTENANCE AND CHECKS	6-1
6.1.	INTRODUCTION.....	6-1
6.1.1.	Error Messages	6-1
6.1.2.	Model 6622A Setup Warnings.....	6-1
6.1.3.	Fault Indication.....	6-3
6.1.4.	Maintenance	6-3
6.1.5.	Maintenance Guidelines and Schedule	6-3
6.1.6.	Connection Problems	6-4
6.1.7.	Safety Features	6-4
7.	APPENDICES	7-1
7.1.	GENERAL SPECIFICATIONS	7-1
7.2.	GENERAL SPECIFICATIONS (continued)	7-2
7.3.	RESISTANCE MEASUREMENT SPECIFICATION.....	7-2
7.4.	CABLE CONNECTION DIAGRAMS	7-3

LIST OF FIGURES

FIGURE 1-1 : MODEL 6623A-150 BLOCK DIAGRAM 1-3
FIGURE 2-1 : LINE VOLTAGE INPUT 2-2
FIGURE 2-2 : 6623A-150 FRONT VIEW 2-9
FIGURE 2-3 : 6623A-150 REAR VIEW 2-10
FIGURE 3-1 : RESISTANCE MEASUREMENT RESPONSE VERSUS TEST SAMPLE 3-1
FIGURE 5-1 : MODEL 6623A-150 SETUP WITH MODEL 6622A, X20-3A RANGE 5-3
FIGURE 5-2 : MODEL 6623A-150 SETUP WITH MODEL 6622A, X100-15A RANGE 5-5
FIGURE 5-3 : MODEL 6623A-150 SETUP WITH MODEL 6622A, X1000-150A RANGE 5-7
FIGURE 7-1 : SINGLE CABLE CONNECTION 7-3
FIGURE 7-2 : TWO CABLE HORIZONTAL CONNECTION 7-3
FIGURE 7-3 : TWO CABLE VERTICAL CONNECTION 7-4

LIST OF TABLES

TABLE 2-1 : FUSE RATINGS.....	2-2
TABLE 3-1 : 6623A-150 RECOMMENDED LOW OHMS MODE TEST SETUP	3-6
TABLE 6-1 : MODEL 6622A AND 6623A-150 ERROR MESSAGES	6-2
TABLE 6-2 : MAINTENANCE SCHEDULE.....	6-3
TABLE 7-1 : GENERAL SPECIFICATIONS.....	7-1
TABLE 7-2 : GENERAL SPECIFICATIONS (CONTINUED).....	7-2

1. INTRODUCTION

1.1. SCOPE

This document describes the installation, operation, specifications, maintenance and verification of the Model 6623A-150 High Current Range Extender for the 6622A series of Automatic DCC Resistance Bridges. Precautions associated with very high current connections and measurements are provided for purposes of user safety and measurement system reliability.

1.2. GENERAL DESCRIPTION

The Model 6623A-150 High Current Range Extender extends the test current and measurement range of the Guildline Instruments 6622A series of Automatic DCC Resistance Bridges.

The extender is essentially a direct current transformer with primary windings which produce an output current that varies directly proportional to the input current. The windings provide transformation ratios of 20:1, 100:1 and 1000:1 and allow for measurements to be performed above the 150 mA capability of the DCC Resistance Bridge up to a maximum of 150 Amperes. Three current ranges are provided, 0.1 to 3 A, 3 to 15 A, and 15 to 150 A, with current ratios of 20:1, 100:1 and 1000:1 respectively.

The 6623A-150 allows measurements to be made that reduce thermal and current offset effects with the inclusion of an electronically switched current source and all the control circuits necessary for complete control through the 6622A series of bridges. All necessary interconnections of the 150 A current source are integrated into one chassis such that no hardware reconfiguration is required over the full range of operation other than the connection of the current terminals of the resistance to be measured to the correct range on the back panel.

No assembly or requirement for ancillary components such as external current sources or current reversing relays is needed for full utilization of the 6623A series of high current range extenders. Only connections to the power source and the 6622A Bridge are required as described in this manual.

The 6623A-150 is fully programmable via the 6622A series of bridges with the system or via software if automation is desired. The programming is accomplished via the Bridge's Low Ohms menu. Programming includes selection of the current ratio, (current output), automated reversal rates, and actual required test current output(s).

1.3. OVERVIEW

The Model 6623A-150 High Current Range Extender is a precision, fixed ratio, direct current transformer based on the principle of the direct current comparator. Figure 1-1 illustrates the instrument circuits in block diagram form with the connections to the 6622A Bridge. A precision programmable current source is incorporated into the extender such that measurements can be fully automated through the 6622A current comparator resistance bridge using either front panel setup or fully automatic computer control. The 6623A-150 High Current Range Extender is connected to the 6622A Bridge using a seven conductor cable with circular connectors.

No adjustments of the 6623A-150 High Current Range Extender are required for proper operation, but the 6622A Bridge must be set up with a specific range extender profile. The 6622A Bridge is generally configured at the factory for a specific range extender whenever a range extender is ordered at the same time. Where a range extender is ordered subsequently to that of ordering a bridge, the specifics of the profile including current and ratio correction coefficients are provided.

1.4. PRINCIPLE OF OPERATION

The Direct Current Comparator is a multiple winding toroidal transformer device shown in Figure 1-1 in which the primary and secondary windings carry direct currents and in which modulator and detector windings are used for the detection of DC flux in the core. When the primary and secondary ampere-turns are equal and opposite there is zero resultant DC flux in the core. This balance condition can be detected by the flux detector circuit. The DC output of the detector is proportional to ampere-turn imbalance. The presence of DC flux in the cores due to primary-secondary ampere-turns imbalance is indicated by the detector output both in magnitude and polarity.

The peak detector drives a servo circuit to provide correction current which maintains ampere-turn balance in the core at all times such that the ratio of input and output currents is exactly 20:1, 100:1 or 1000:1 depending on which range of operation is selected.

The 6622A Bridge provides a drive signal to the programmable current source as to allow test currents of 150 mA to 150 A to be realized. This current is directed to the primary windings of the toroidal transformer and the servo amplifier output drives a balancing current through the secondary winding which is directed back to the 6622A such that the bridge can also be balanced with the reduced current. The 6622A Bridge can then determine the resistance ratio of the test resistor with that of the reference resistor used in the measurement. Refer to the 6622A Operation Manual for a description of the bridge measurement technique.

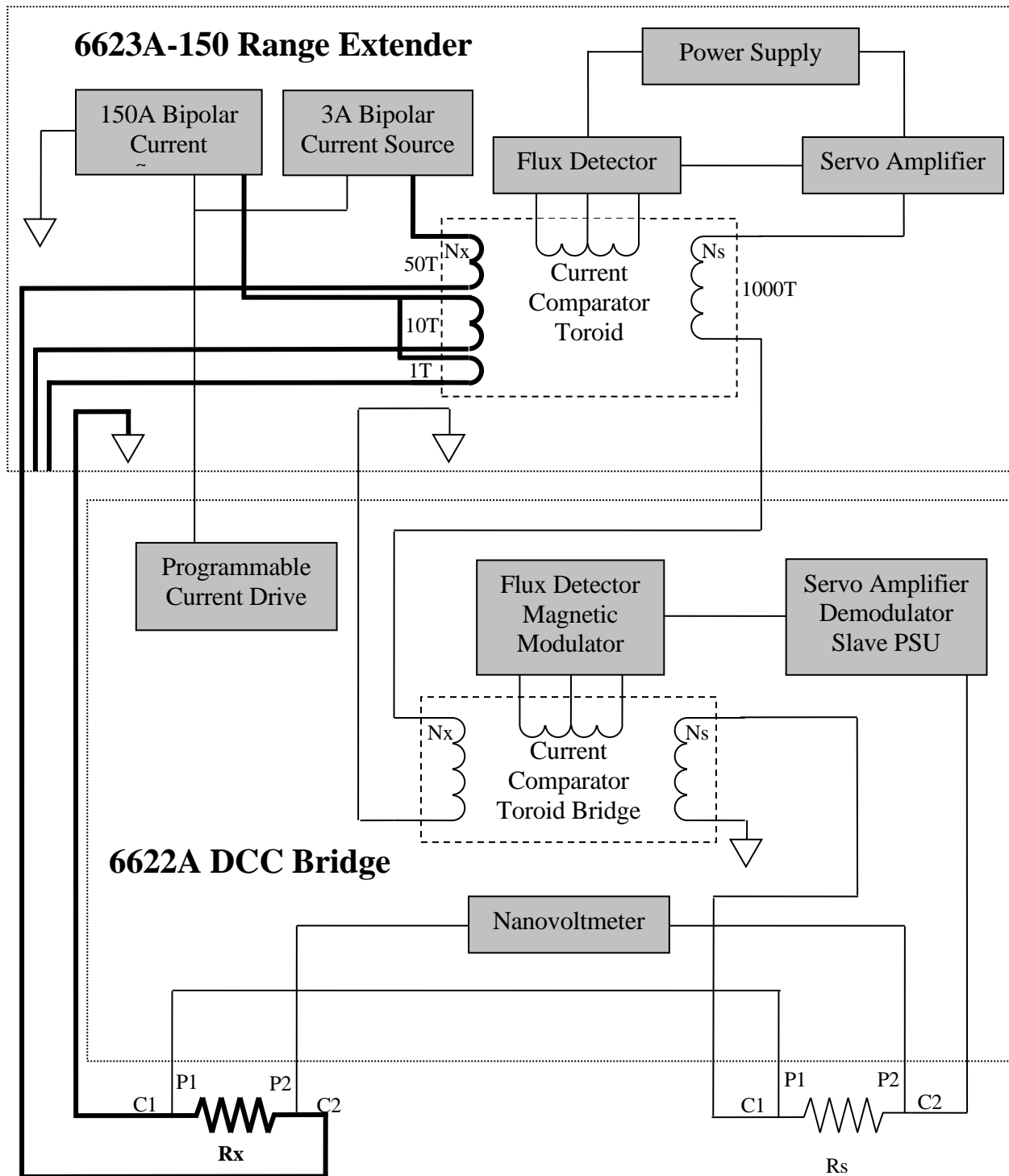

Figure 1-1 : Model 6623A-150 Block Diagram

2. INSTALLATION

2.1. PRELIMINARIES

2.1.1. Unpacking

- a. Remove the 6623A-150 High Current Range Extender and the other items from the shipping container to a suitable location. Note that the Range Extender may be delivered as part of an automated resistance measurement system. If this is the case then the Range Extender will have already been set up with the proper fuses installed and connected to the DCC Bridge in the system.
- b. The following items are included with each new unit:
 - i. Operation Manual (OM6623A-150)
 - ii. Two Spare Fuses 20 A Slow Blow, (GPN 099-28521)
 - iii. Four Spare Fuses 6.3 A Slow Blow, Ceramic Tube (GPN 099-26301)
 - iv. Four Spare Fuses 3.15 A Slow Blow, Ceramic Tube (GPN 099-23151)
 - v. Two Spare Fuses 200 A, Blade (GPN 099-32200)
 - vi. One SCW Lead, 2 m (GPN 20236.04.02)
 - vii. One 20 A, 1.5 m red connection cable (GPN 996-00105)
 - viii. One 20 A, 1.5 m black connection cable (GPN 996-00104)
 - ix. One 150 A, 1.5 m red connection cable (GPN 20239.03.02)
 - x. One 150 A, 1.5 m black connection cable (GPN 20239.04.02)
 - xi. 7 conductor, 2 m bridge connection cable (GPN# 20212.04.02)
 - xii. AC Line Cord, (GPN# 250-04030)

2.1.2. Power Voltage Selection

The 6623A-150 High Current Range Extenders are shipped without the fuses installed in the power entry module. There is no line input selector but the correct fuse must be installed before power is applied to the instrument. Refer to Table 2-1 for the correct fuse selection. The 6623A-150 is designed for universal use of AC power sources from nominal 100 Volts to 240 Volts in a frequency range of 50 Hz to 60 Hz.

Where the molded plug on the line cord supplied with the instrument does not match the local power outlet socket, the plug can be removed and replaced with one that does fit the local service. The plug should be re-wired as follows:

Brown wire	-	Line input
Blue wire	-	Neutral input
Green/Yellow	-	Ground (safety)

2.1.3. Fuse Replacement

Only fuses with specified current rating type should be used for replacement if necessary. See Table 2-1.

FUSES (TIME DELAY TYPE)			
100 V	120 V	220 V	240 V
6.3 A, 250 V, (T)	6.3 A, 250 V, (T)	3.15 A, 250 V, (T)	3.15 A, 250 V, (T)

Table 2-1 : Fuse Ratings

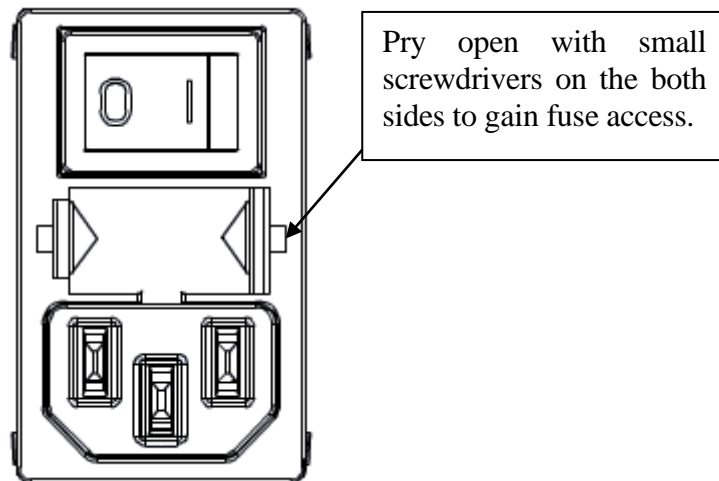

Note: No external line voltage/frequency selection is required for power entry. Only the correct line fuses must be installed for the specific Line Voltage. Two fuses are required.

Figure 2-1 : Line Voltage Input

2.1.4. Setup and Power On

- a. Verify that the power switch is off.
- b. Remove any excess packing materials from around the front and back panels that is provided for shipping purposes only.
- c. Install the correct fuse before power is applied to the instrument as shown in Section 2.1.3.
- d. Connect the extender to the 6622A Bridge using the 7 conductor cable with the circular connectors. The end with the exposed green shield leads is to be connected to the circular connector on the back panel of the 6622A marked 'EXTENDER' and the other end to the circular connector of the 6623A-150 Extender marked 'BRIDGE'.
- e. Connect the input power cord from the 6623A-150 to the AC power outlet.
- f. Turn on the power switch to the 6622A Bridge.

Note 1: Do not power on the 6623A-150 with a shunt connected to one of the output current ranges on the back panel. Connect the load AFTER the 6623A-10 is turned on.

Note 2: Do not cycle the power on the 6623A-10 with a shunt or load connected to one of the ranges on the back panel.

Note 3: Only connect a load to one set of output current terminals.

Note 4: Do NOT connect a load (e.g. shunt) to more than one set of output current terminals at the same time.

Note 5: Do not connect or disconnect the load when the measurement is running.

- g. Turn on the power switch to the 6623A-150. You should see the red 'POWER' indicator on the front panel light up. The yellow 'FAULT' indicator will light up for about 6 seconds then remain off unless a fault in the range extender circuits is detected. The red indicator will remain lighted as long as power is applied to the instrument.
- h. The system should now be ready to use. Refer to section 2.2. to complete a functional test of the 6623A-150.
- i. Note that the operator must be familiar with the various modes of operation of the 6622A Bridge before using the 6623A-150 Range Extender. The 6622A Operation Manual should be reviewed before proceeding.

Note 6: Do not connect the current terminals of the test resistor through a scanner if test currents above 2 amperes will be selected.

Note 7: It is recommended to keep the 6623A-150 High Current Range Extender power off when the instrument is not in use for extended periods of time.

2.2. INCOMING INSPECTION

If no errors are displayed during power up of the 6622A Bridge and Range Extender, (see section 2.1.4.g.) then proceed to measure a 0.1 ohm resistor referenced to a 1 ohm standard. Note that the 6622A Bridge may require a firmware upgrade if it has not been shipped with the range extender. Refer to the 6622A Operation Manual for information on setting up or checking the range extender profile. If the bridge was shipped with the range extender then the extender profile would have been created in the bridge before shipment.

Use the following measurement set up procedure to verify the functional performance of the range extender. Details of setting up a measurement profile for 'Low Ohms' operation using a range extender are provided in the 6622A Operation Manual in section 4.6.5.3. Where a scanner is to be used in the connections to the resistors, the current terminals of the resistor to be measured should not be connected through a scanner channel. Only the potential terminals should be connected to the resistor being measured.

Note 1: A proper extender profile must have been created in the non-volatile memory of the 6622A for the 6623A-150 Range Extender before proceeding.

Note 2: Do not power on the 6623A-150 with a shunt connected to one of the ranges on the back panel. Powering on the Range Extender with a load can cause a fault to occur. Refer to section 2.3.2. for Fault Indications.

Note 3: Do not connect more than one shunt to the back panel terminals at one time.

Initially the measurement of the 0.1 ohm shunt with the 6622A Bridge is used as a ratio reference with a test current of 150 mA. Then, it is measured a second time with the 6623A-150 Range Extender at the same current level. The difference between the two measurements must be within specified limits to qualify the functionality of the first x20-3A range of the range extender. The exact values of the resistors are not required as only the measured ratio of the resistors is of concern to verify the functional performance of the range extender.

Also, a 0.001 ohm Shunt resistor is measured using both the x100-15A range and the x1000-150A range with a test current of 15 A, to qualify the integrity of these two ranges. Section 5 provides the procedure for a full verification of the 6623A-150 Range Extender. Use the 20 A rated cables provided for connecting the current terminals of the range extender to the shunt.

The following is a step by step procedure for connecting the resistors and for setting up the bridge properly to make the measurements.

- Step 1)** Connect a 1 ohm resistance standard to the Rs terminals and 0.1 ohm resistance standard to the Rx terminals of the 6622A Bridge.
- From the front panel of the Model 6622A select 'Setup' from the main menu functions.
 - From the Setup menu, configure the measurement setup as follows:
 - Select 'Normal' mode function key.

- Select 'Edit' function key.
- Enter 1 on highlighted 'Resistance RS:' line on display by using the numeric key pad.
- Select the down arrow key to highlight the next line on the display.
- Leave standard resistor serial number under 'Serial No. RS:' line blank.
- Select the down arrow key to highlight the next line on the display.
- Enter 0.1 on highlighted 'Resistance RX:' line on display by using the numeric key pad.
- Select the down arrow key to highlight the next line on the display.
- Enter in 60 for the reversal rate for the measurement.
- Select the down arrow key to highlight the next line on the display.
- Enter 150 mA test current value for the test.
- Select the down arrow key to highlight the next line on the display.
- Enter the maximum Rs current value of 150 mA.
- Verify that all entered data is correct, and then press 'OK'.

Step 2) Press the 'Previous' function key twice to come back to the main menu.

Step 3) Press the 'Measure' function key and then the 'Ratio' menu function to display Ohms. Press the 'Meas Off ' sub-menu function key to start the measurement. The 6622A Bridge will begin by showing the nominal value of the resistor to be measured, and then continue to go through a number of rough measurement cycles until a full resolution measurement value is displayed. The measurement may be stopped at any time by pressing the 'Meas On' menu key.

Step 4) Record the ohms value displayed after about 15 minutes of measuring and stop the measurement.

Step 5) Disconnect the leads connected to the Rx C1 and C2 terminals of the 6622A and connect them to the C1 and C2 terminals of the x20-3A range on the back panel of the 6623A-150. See Figure 5-1 showing rear panel connections.

Step 6) On the front panel of the 6622A press the previous key to return to the main menu and perform the following set up:

- From the front panel of the Model 6622A select 'Setup' from the main menu functions.
- From the Setup menu, configure the measurement setup as follows:
- Select 'Low Ohms' mode function key.
- Press the right hand key until the selection '6623A-150' is shown and select 'Edit' function key.
- Enter 1 on highlighted 'Resistance RS:' line on display by using the numeric key pad.
- Select the down arrow key to highlight the next line on the display.
- Leave standard resistor serial number under 'Serial No. RS:' line blank.

- Select the down arrow key to highlight the next line on the display.
- Enter 0.1 on highlighted 'Resistance RX:' line on display by using the numeric key pad.
- Select the down arrow key to highlight the next line on the display.
- Enter in 60 for the reversal rate for the measurement.
- Select the down arrow key to highlight the next line on the display.
- Enter 20 for the extender ratio range to be used.
- Select the down arrow key to highlight the next line on the display.
- Enter 0.150 A for the test current value.
- Select the down arrow key to highlight the next line on the display screen 2-2.
- Enter the maximum Rs current value of 150 mA.
- Verify that all entered data is correct, and then press 'OK'.

Step 7) Press the 'Previous' function key twice to come back to the main menu.

Step 8) Press the 'Measure' function key and then the 'Meas Off ' sub-menu function key to start the measurement. The 6622A Bridge will begin by showing the nominal ohm value of the resistor to be measured, and then continue to go through a number of rough measurement cycles until a full resolution measurement value is displayed. The measurement may be stopped at any time by pressing the 'Meas On' menu key.

Step 9) Record the ohms value displayed after about 15 minutes of measuring and then stop the measurement. Calculate the difference between the two measurement results. The difference should be less than +/- 0.00001 ohms, (100 uΩ/Ω), depending on the stability of the resistors used in the test.

Step 10) Disconnect the leads connected to the Rx C1 and C2 terminals of the x20-3A range and connect them to the C1 and C2 terminals of the x100-15A range on the back panel. See Figure 5-2 showing rear panel C1 and C2 connections. Remove the 0.1 ohm resistance standard from the test leads and install a 0.001 ohm current shunt in its place.

Step 11) On the front panel of the 6622A press the previous key to return to the main menu and perform the following set up:

- From the front panel of the Model 6622A select 'Setup' from the main menu functions.
- From the Setup menu, configure the measurement setup as follows:
- Select 'Low Ohms' mode function key.
- Press the right hand key until the selection '6623A-150' is shown and select 'Edit' function key.
- Enter 1 on highlighted 'Resistance RS:' line on display by using the numeric key pad.
- Select the down arrow key to highlight the next line on the display.

- Leave standard resistor serial number under 'Serial No. RS:' line blank.
- Select the down arrow key to highlight the next line on the display.
- Enter 0.001 on highlighted 'Resistance RX:' line on display by using the numeric key pad.
- Select the down arrow key to highlight the next line on the display.
- Enter in 60 for the reversal rate for the measurement.
- Select the down arrow key to highlight the next line on the display.
- Enter 100 for the extender ratio range to be used.
- Select the down arrow key to highlight the next line on the display.
- Enter 15 A for the test current value.
- Select the down arrow key to highlight the next line on the display screen 2-2.
- Enter the maximum Rs current value of 150 mA.
- Verify that all entered data is correct, and then press 'OK'.

Step 12) Press the 'Previous' function key twice to come back to the main menu.

Step 13) Press the 'Measure' function key and then the 'Meas Off ' sub-menu function key to start the measurement. The 6622A Bridge will begin by showing the nominal ohm value of the resistor to be measured, and then continue to go through a number of rough measurement cycles until a full resolution measurement value is displayed. The measurement may be stopped at any time by pressing the 'Meas On' menu key.

Step 14) Record the ohms value displayed after about 15 minutes of measuring and then stop the measurement.

Step 15) Disconnect the leads connected to the x100-15A C1 and C2 terminals and connect them to the C1 and C2 terminals of the x1000-150A range on the back panel. See Figure 5-3 showing rear panel C1 and C2 connections.

Step 16) On the front panel of the 6622A press the previous key to return to the main menu and perform the following set up:

- From the front panel of the Model 6622A select 'Setup' from the main menu functions.
- From the Setup menu, configure the measurement setup as follows:
- Select 'Low Ohms' mode function key.
- Press the right hand key until the selection '6623A-150' is shown and select 'Edit' function key.
- Enter 1 on highlighted 'Resistance RS:' line on display by using the numeric key pad.
- Select the down arrow key to highlight the next line on the display.
- Leave standard resistor serial number under 'Serial No. RS:' line blank.
- Select the down arrow key to highlight the next line on the display.

- Enter 0.001 on highlighted 'Resistance RX:' line on display by using the numeric key pad.
- Select the down arrow key to highlight the next line on the display.
- Enter in 60 for the reversal rate for the measurement.
- Select the down arrow key to highlight the next line on the display.
- Enter 1000 for the extender ratio range to be used.
- Select the down arrow key to highlight the next line on the display.
- Enter 15 A for the test current value.
- Select the down arrow key to highlight the next line on the display screen 2-2.
- Enter the maximum Rs current value of 150 mA.
- Verify that all entered data is correct, and then press 'OK'.

Step 17) Press the 'Previous' function key twice to come back to the main menu.

Step 18) Press the 'Measure' function key and then the 'Meas Off ' sub-menu function key to start the measurement. The 6622A Bridge will begin by showing the nominal ohm value of the resistor to be measured, and then continue to go through a number of rough measurement cycles until a full resolution measurement value is displayed. The measurement may be stopped at any time by pressing the 'Meas On' menu key.

Step 19) Record the ohms value displayed after about 15 minutes of measuring and then stop the measurement. Calculate the difference between this measurement result and that of step 14. The difference should be less than +/- 0.0001 milliohms, (100 $\mu\Omega/\Omega$), depending on the stability of the resistors used in the test.

Note: The tests should execute with no measurement errors indicated and should indicate the approximate ohms value of the shunts depending on the actual values of the standards. This is not the 6623A-150 full rated accuracy but serves a functional test for the purposes of determining the instrument has been received in proper working order.

Note: It is recommended to keep the 6623A-150 powered off when the instrument is not in use for extended periods of time.

2.3. 6623A-150 FRONT PANEL

There are no controls on the front panel of the 6623A-150.

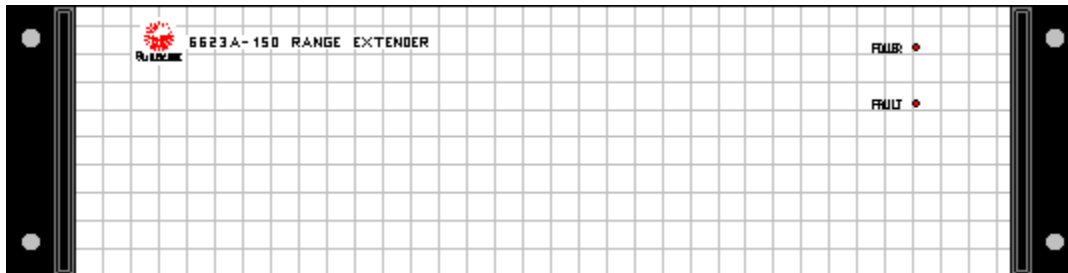

Figure 2-2 : 6623A-150 Front View

2.3.1. Power

The power-on indicator is lighted when the AC power is applied to the unit and the power switch on the rear panel is 'ON'.

2.3.2. Fault

The fault indicator is lighted when a fault condition in the 150 A current source is detected, indicating a circuit fault condition may exist or there is an open circuit on the range extender terminals. The fault indicator will light for about 6 seconds during a power on sequence.

2.4. 6623A-150 REAR PANEL CONNECTORS AND CONTROLS

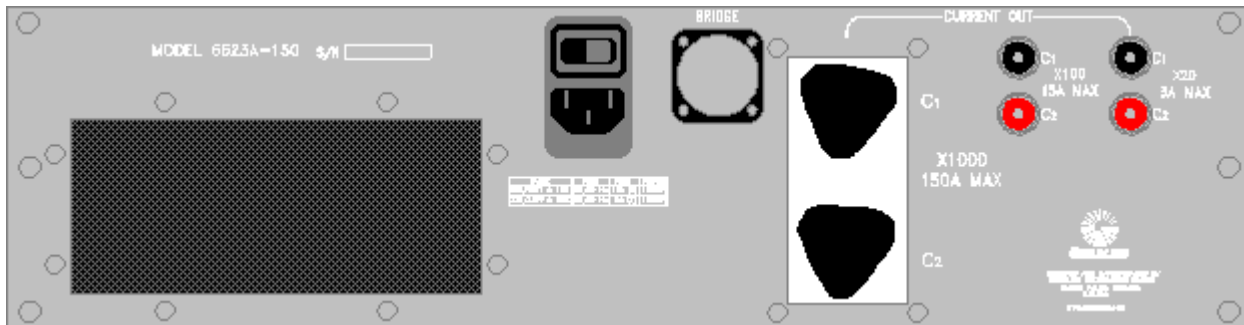

Figure 2-3 : 6623A-150 Rear View

2.4.1. Line Input Connector

The Line Input Connector is a combination of a 3-prong AC standard male connector, an ON/OFF switch and a fused line input with access for fuse replacement. The line input connector accommodates nominal voltages of 100 V, 120 V, 220 V and 240 V. A 6.3 Amp time delay fuse is provided for the 100/120 V operation and a 3.15 Amp time delay fuse is provided for the 220/240 V operation. The appropriate fuse must be selected and installed before the instrument is turned on during the installation of the instrument.

2.4.2. Resistor Under Test Terminals

The Resistor Under Test current terminals consist of three sets of two binding posts. These binding posts are labeled as C1 and C2 for each current range of x20-3A, x100-15A and x1000-150A maximum. These terminals are to be connected to the C1 and C2 terminals of the Resistor Under Test whenever the current range extender is to be used. The potential terminals of the Resistor Under Test are always to be connected to the Rx P1 and P2 terminals of the 6622A Bridge.

The x100-15A terminal output is protected from over-current with a 20 A fuse internal to the instrument.

2.4.3. Bridge Connector

The Bridge connector is a 7 pin circular connector which is used to connect the necessary signals to the Model 6622A Bridge.

2.4.4. Cautions

1. **It is essential that only one set of C1 and C2 current terminals be connected at any one time and the shunt current leads are connected to the correct C1 and C2 range terminals for a specific measurement current.**
2. **Do not power on the 6623A-150 with a shunt connected to one of the ranges on the back panel.**
3. **Do not connect the current terminals of the test resistor through a scanner if test currents above 2 amperes will be selected.**
4. **Ensure that cables used are rated for required currents and are tightened down.**

3. QUICK MEASUREMENT GUIDE

3.1. MEASUREMENT OPERATION GUIDE

This section contains information regarding the measurement of resistors in the range of 1 μohm to 10 ohms. This guide is provided for manual control of the 6623A-150 from the front panel of the 6622A Bridge. An operation guide for full automatic control of the 6623A-150 Range Extender and the 6622A Bridge through the terminal of the system computer is provided in the BridgeWorks, version 2.1b or higher, Software User Manual.

A typical example of a resistance measurement response versus test sample is illustrated in Figure 3-1.

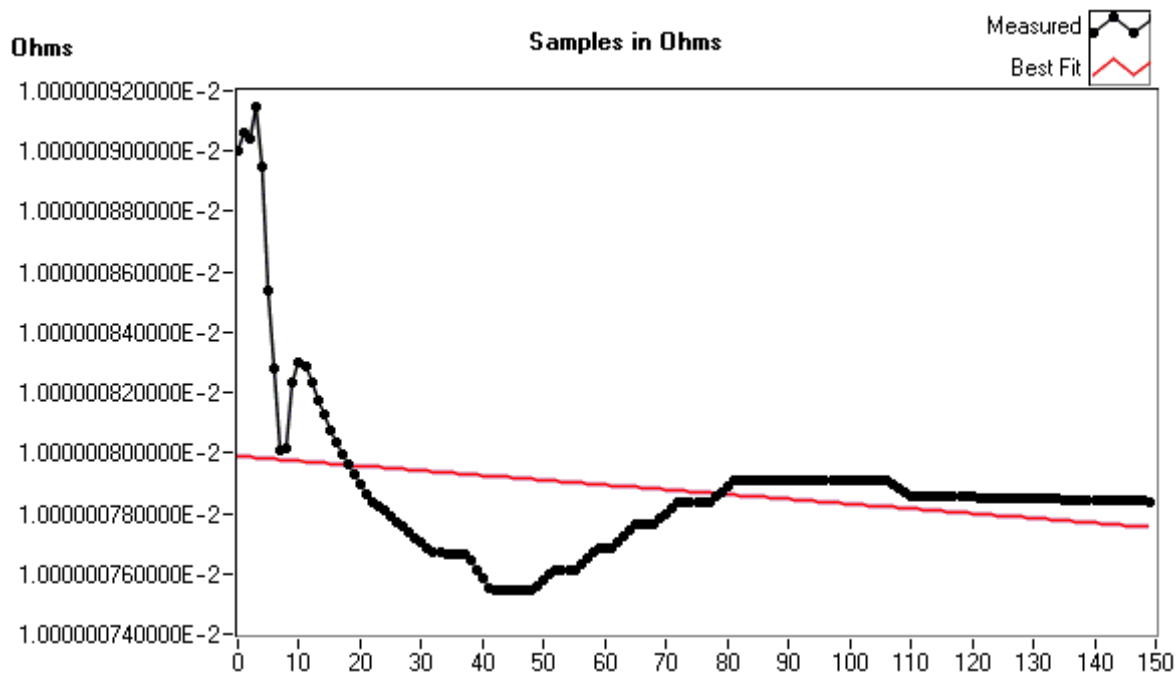

Figure 3-1 : Resistance Measurement Response Versus Test Sample

NOTE: 1. The last 35 samples of a total of 150 measurement samples should be used to determine the mean measurement value and standard deviation of the sample set, to allow for sufficient stabilization time to achieve the specified measurement uncertainty for the Model 6622A with the 6623A-150.

3.1.1. Low Ohms Mode Resistance Measurement for all 6622A Models with the 6623A-150

The 6622A Bridge in Low Ohms Mode enables measurement of resistors below 100 ohms. When used with a Model 6623A-150 High Current Range Extender, measurement of low ohm resistors can be made at a maximum test current up to 150 A.

Cautions:

1. **It is essential that only one set of C1 and C2 current terminals be connected at any one time to a load (e.g. shunt). Only connect a load to one set of output current terminals.**
2. **Do not cycle the power on the 6623A-150 with a shunt or load connected to one of the ranges on the back panel. Connect the load AFTER the 6623A-150 is turned on. Disconnect the load BEFORE turning off the 6623A-150.**
3. **Do not connect or disconnect the load when the measurement is running.**
4. **Make sure shunt current leads of sufficient size are connected to the correct C1 and C2 range terminals for a specific measurement current.**
5. **Do not connect the current terminals of the test resistor through a scanner if test currents above 2 amperes will be selected.**
6. **Warm up time of 45 minutes is recommended to meet full specifications.**

The operator must be familiar with the various modes of operation of the 6622A Bridge before using the 6623A-150 Range Extender. The 6622A Bridge Operation Manual should be reviewed before proceeding.

The following is a basic step by step procedure for connecting the resistors and for setting up the bridge properly to make the measurements. Refer to sections 3.1.5. and 3.1.6. for precautions with high current connections.

Step 1) Connect the bridge, reference standard, and the 6623A-150 range extender. Turn on the bridge first, then turn on the 6623A-150 range extender, then connect the load (e.g. shunt or UUT). Connections are as shown in the appropriate connection diagrams in section 5. Use appropriate leads to carry the currents which are provided in the spare parts kit. The current leads must be connected to the appropriate current range terminals on the back panel of the 6623A-150. See section 3.1.2. for test setup limits for each current range.

Step 2) Make sure the selection of working standard resistor is appropriate. For measurement of low ohm resistors, usually a 1 Ω reference is chosen unless the resistor nominal value is higher than 0.1 ohms or high current requirements require the use of a 10 Ω or 100 Ω working standard resistance. See Table 3-1.

Step 3) From the front panel of the Model 6622A Bridge select 'Setup' from the main menu functions. Table 3-1 shows a summary of recommended test setups.

From the Setup menu, configure the measurement setup as follows:

- Select 'Low Ohms' mode function key.
- Options at this level are 'Edit' (test setup information), 'OK' (to accept) or '6623A-150'. Make sure the '6623A-150' mode is selected with the specific range to be used. This can be done by pressing the softkey until the displayed value is changed to '6623A-150'.
- Select 'Edit' function key.
- Enter standard resistor value on highlighted 'Resistance RS:' line on display by using the numeric key pad.
- Select the down arrow key to highlight the next line on the display.
- The standard resistor serial number may be entered under 'Serial No. RS:' line.
- Select the down arrow key to highlight the next line on the display.
- Enter the nominal value of Rx.
- Enter the reversal rate of 60 seconds for the measurement.
- Select the down arrow key to highlight the next line on the display.
- Set the extender ratio range to be used, 20, 100 or 1000.
- Select the down arrow key to highlight the next line.
- For the Model 6623A-150 Range Extender, enter the test current (for the resistor to be measured) in Amps up to 150 A depending on the current range selected.
- Enter the maximum current value for the Rs standard resistor in mA. The max current needs to be no less than the Rs current shown in Table 3-1 up to a maximum allowable value of 150 mA.
- Select the down arrow key to highlight the next line on the display.
- Verify that all entered data is correct, and then press 'OK'.

Step 4) Press the 'Previous' function key twice to come back to the main menu.

Step 5) Press the 'Measure' function key on the 6622A Bridge and then the 'Meas Off ' sub-menu function key to start the measurement. The 6622A Bridge will begin by showing the nominal value of either the resistor or the ratio to be measured. At this time, the bridge is carrying out a measurement at the current set in the edit menu. Then bridge measurement may be stopped by pressing the 'Meas On' menu key.

3.1.2. Recommended Test Setup Limits for the 6623A-150

See Table 3-1 for the recommended test setups. Note that the current in the standard resistor is controlled by the resistance of the resistor to be measured and the extender current such that the potentials across each resistance are equal and can be determined by the following formula:

1. Standard Resistor Current = Test Resistor Current x (Rx / Rs)

The current in the standard resistor generally should not exceed a power dissipation level of 10 mW.

2. $R_s \geq \text{Ext. Ratio} \times R_x / 2$

The standard resistor for the measurement must be no less than the calculated value in the formula above.

3. Bridge Ratio = $(R_x \times \text{Ext. Ratio}) / R_s$

The bridge measurement ratio should not exceed a value of 2:1 and be no less than 0.02:1 to assure accuracy is within specifications.

3.1.3. Checks and Precautions

- Select the lowest ratio range of the extender that provides the current required for the test.
- Select current leads suitable to handle the maximum test current for a particular range, either the 20 A or the 150 A high current leads.
- Refer to the Table 3-1 to select the most suitable reference resistor value for the measurement.
- Verify that the bridge ratio will be within limits as noted in 3.1.2. formula 3 above.
- Verify that the reference resistor current will not exceed 10 mW dissipation limits.
- Ensure that all current lead connections are tight; loose high current connections can create very high temperatures and arcing.
- It is essential that only one set of C1 and C2 current terminals be connected at any one time and the shunt current leads are connected to the correct C1 and C2 range terminals for a specific measurement current.
- Do not power on the 6623A-150 with a shunt connected to one of the ranges on the back panel.
- Do not connect the current terminals of the test resistor through a scanner if test currents above 2 amperes will be selected.

CAUTION: Loose High Current Connections Can Create Very High Temperatures and Arcing.

It is recommended to keep the 6623A-150 power off when the instrument is not in use for extended periods of time.

3.1.4. Example Calculations

For example, if a 0.01 ohm shunt is to be measured at 10 A:

1. **The extender range x100-15A** is required to satisfy the test current requirement.
2. The standard resistor must be at least: $R_s = 100 \times 0.01 / 2 = 0.5$ ohm or higher, so choose a standard resistor of 1 ohm.
3. The standard resistor test current will be:
$$I_s = 10 \times 0.01 / 1 = 0.1 \text{ A}$$
4. The power dissipation level will be:
$$W = 0.1 \times 0.1 \times 1 = 0.01 \text{ Watts.}$$
5. Since this is an acceptable dissipation level then a standard resistor of 1 ohm would be chosen.
6. The **bridge ratio** then will be:
$$\text{Ratio} = 0.01 \times 100 / 1 = 1$$
7. The ratio is acceptable as it is between 2:1 and 0.02:1.
8. By looking up the Table 3-1, scan down the **Rx Resistor** column and locate the row that includes the 0.01 ohm value in the range and also has a **Ix-max** value greater than or equal to the 10 A. You will notice the row with an **Rs value of 1 ohm** also is within range for an **Ix-max value of 10 A** with an **Rs current** of 100 mA or less.

3.1.5. Test Current Cable Size

Always choose a cable size large enough to prevent excessive temperature rise in the cables which will have an adverse effect on the resistance of the shunt being measured. Above 50 A test current and up to 150 A, a cable size of 1/0 AWG should be used. Above 15 A, up to 50 A, a cable size of 4 AWG or larger should be used. Below 15 A test current 12 AWG cable size is adequate. Note that an excessively small cable size can result in melting and charring of the insulation on the cable.

3.1.6. Use of Multiple Cable Connections

Some current shunts have multiple points for connection. In these cases it may be advisable to use an even number of cables on the terminal ends and connect the cables such that the connections are symmetrical around the terminal end so that connection effects are minimized. Refer to Appendix 7.4 for illustration of symmetrical connections.

Rs (Ω)	Rx Resistor (Ω)	I _{x-max} (A)	Rs Current (mA-max)	Extender Ratio/Range	Reversal Rate (sec)	Comment
1000	1 - 10	0.5	5	20:1 / 3A	60	Limit of Voltage Compliance
100	0.32 - 1	1	10	20:1 / 3A	60	Limit of 10 mW in Rs
100	0.1 - 0.32	3	9.6	20:1 / 3A	60	Limit of x 20, 3A Range
10	0.32 - 1	0.32	32	20:1 / 3A	60	Limit of 10 mW in Rs
10	0.05 - 0.1	3	30	20:1 / 3A	60	Limit of x 20, 3A Range
1	0.05 - 0.1	1	100	20:1 / 3A	60	Limit of 10 mW in Rs
1	0.01 - 0.05	2	100	20:1 / 3A	60	Limit of 10 mW in Rs
1	0.005 - 0.01	3	30	20:1 / 3A	60	Limit of x 20, 3A Range
100	0.05 - 0.1	10	10	100:1 / 15A	60	Limit of 10 mW in Rs
10	0.05 - 0.1	3.2	32	100:1 / 15A	60	Limit of 10 mW in Rs
10	0.01 - 0.05	6.4	32	100:1 / 15A	60	Limit of 10 mW in Rs
10	0.005 - 0.01	15	15	100:1 / 15A	60	Limit of x 100/15A Range
1	0.005 - 0.01	10	100	100:1 / 15A	60	Limit of 10 mW in Rs
1	0.001 - 0.005	15	75	100:1 / 15A	60	Limit of x 100/15A Range
100	0.005 - 0.01	100	10	1000:1 / 150A	90	Limit of 10 mW in Rs
10	0.005 - 0.01	32	32	1000:1 / 150A	90	Limit of 10 mW in Rs
100	0.001 - 0.005	150	7.5	1000:1 / 150A	90	Limit of x 1000/150A Range
10	0.001 - 0.005	64	32	1000:1 / 150A	90	Limit of 10 mW in Rs
10	0.0005 - 0.001	150	15	1000:1 / 150A	90	Limit of x 1000/150A Range
1	0.0001 - 0.0005	150	75	1000:1 / 150A	90	Limit of x 1000/150A Range
1	0.00005 - 0.0001	150	15	1000:1 / 150A	90	Limit of x 1000/150A Range
1	0.00001 and lower	150	1.5	1000:1 / 150A	90	Limit of x 1000/150A Range

Table 3-1 : 6623A-150 Recommended Low Ohms Mode Test Setup

NOTES:

- 1. The last 35 samples of a total of 150 measurement samples should be used to determine the mean measurement value and standard deviation of the sample set, to allow for sufficient stabilization time to achieve the specified uncertainty for the Model 6622A Bridge with the 6623A-150 High Current Range Extender.**
- 2. Refer to the 6622A Operation Manual for the complete resistance ratio and test current measurement specifications of the 6623A-150 with the 6622A Bridge in Low Ohms mode of operation.**
- 3. It is recommended to keep the 6623A-150 powered off when the instrument is not in use for extended periods of time.**
- 4. A warm up time of 45 minutes is recommended to meet full specifications.**

3.2. BRIDGEWORKS DATA ACQUISITION SOFTWARE

The BridgeWorks, version 2.1b or higher, Data Acquisition Software is the control software for the 6622A Series Automatic DCC Resistance Bridges and the 6623A series of High Current Range Extenders. Using the 6622A with the BridgeWorks Data Acquisition Software will increase the functionality and the productivity of the bridge. Adding optional 6664C Scanner(s) to work along with 6622A Series bridges and software control will create a fully automated Resistance Measurement System. Before using the 6622A with the computer, ensure that the operation of the software package is well understood. The computer controls the system through the IEEE-488 Interface (GPIB) of the 6622A, and optionally, the Model 6664C.

Refer to the BridgeWorks Software User Manual for a description of the software functions and automatic operation of the system under software control.

Warning: It is strongly advised that you do not attempt to change any parameters manually while under software control. If manual intervention is viewed as necessary, it should only occur while the software is either closed or displaying an error message.

Warning: Do not connect the current terminals of the test resistor through the scanner if test currents above 2 amperes will be selected.

4. INSTRUMENT OPERATION

4.1. FRONT PANEL OPERATING PROCEDURE

The 6622A Bridges and 6623A-150 High Current Range Extenders are manually operable from the front panel of the 6622A. The BridgeWorks Software User Manual contains the operating instructions for fully automatic software control of the 6622A Automatic DCC Resistance Bridge and the 6623A-150 High Current Range Extender via the computer system.

The Model 6622A Operation Manual contains the full detailed operating instructions for manual operation of the bridge including the range extender operation.

Section 3 of this manual provides basic instructions as a quick guide to making measurements with the 6623A-150.

Note: A proper extender profile must have been created in the non-volatile memory of the 6622A Automatic DCC Resistance Bridge for the 6623A-150. Provision is made in the extender profile for calibration coefficients in regard to test current accuracy and extender ratio accuracy. See section 4.6.6.8.1. of the 6622A Operation Manual for details of checking, modifying and setting up a range extender profile.

5. VERIFICATION AND CALIBRATION

5.1. RATIO ACCURACY VERIFICATION

This procedure covers the ratio accuracy verification of the 6623A-150 High Current Range Extender. The following procedure can be automated by using a Bridgeworks Data Acquisition Software test sequence if the 6622A Bridge is connected through a 6664C scanner. Note that automatic range selection on the 6623A-150 is not available through Bridgeworks. The current leads must manually be changed over from one range to another as required.

Do not connect the current terminals of the test resistor through the scanner if test currents above 2 amperes will be selected. Provision is made in the 6622A Bridge Extender Profile for extender test current and ratio calibration correction coefficients.

5.1.1. Purpose

The purpose of this procedure is to assure that the 6623A-150 High Current Range Extender meets the manufacturer's specifications. It is recommended that these procedures be performed after any corrective maintenance activity, or if the operator perceives a problem with respect to ratio accuracy.

It is recommended that all of these procedures be performed on an annual basis to verify performance of the 6623A-150 for its recertification. The absolute value accuracy of the specified standard resistor and the shunt resistors to be used in this verification are not of prime importance since the verification is a ratiometric build up process based on an initial ratio measurement using the 6622A Bridge in normal ohms mode.

The following procedure is to be used to verify the calibration of the 6623A-150 High Current Range Extender.

5.2. TEST EQUIPMENT REQUIRED

Test equipment of equivalent performance may be substituted from the list provided.

Description	Model
DC Comparator Bridge	Guildline 6622A
DC Resistance Standard	Guildline 9330/1Ω
DC Current Shunt Standard	Guildline 9230A-30-0.1Ω
DC Current Shunt Standard	Guildline 9230A-100-0.01Ω
DC Current Shunt Standard	Guildline 9230A-300-0.001Ω
Temperature Controlled Oil/Air Bath PC with BridgeWorks Software	Guildline 5010, 5031 or 5032

Note: The 6623A-150 is calibrated at the factory using a temperature controlled oil bath controlled to within ± 0.02 °C. If the ambient conditions in the laboratory are sufficiently controlled to within ± 0.5 °C the verification procedure below may be used without a bath with precautions that the environment around the standards is kept as stable as possible and the additional uncertainties due to temperature variations are taken into account.

5.3. PROCEDURE

5.3.1. PRELIMINARY MEASUREMENT OF THE 9230A-30A-0.1 SHUNT

1. Place the 9330/1 Ω Resistance Standard and the Current Shunt Standards in the Bath and allow stabilizing in temperature at 25.0 °C.
2. Connect the 9330/1 Standard to the 6622A Current Comparator Bridge Rs terminals and connect the 9230A-30-0.1 Ω Current Shunt to the Rx terminals of the 6622A.
3. Measure and record the ohms value of the 9230A-30-0.1 Ω Shunt Resistance using a current of 150 mA and reversal rate of 60 seconds. Ensure that adequate time is allowed for full stabilization of the measurement. Only the last 35 measurement samples of a full stabilization period of 150 samples is to be used to determine the measurement value and associated standard deviation of the sample set. Record the value of the measurement.
4. Note: The 6623A-150 is not in operation with the 6622A Bridge at this time. See the 6622A Operation Manual for proper operation of the 6622A Automatic DCC Comparator Bridge.

5.3.2. VERIFICATION OF THE x20-3A RATIO OF THE 6623A-150 RANGE EXTENDER

1. Remove the leads from the 6622A Comparator Bridge RxC1 and RxC2 terminals and connect to the 6623A-150 High Current Range Extender C1 and C2 terminals of the x20-3A Range.
2. Ensure that 6623A-150 High Current Range Extender is connected to the 6622A Comparator Bridge with the 7 conductor cable provided with the 6623A-150. (See Figure 5-1) **Do not power on the extender with a shunt connected.**
3. Set the 6622A Bridge, using the front panel menu or software control, for a measurement in 'Low Ohms' mode with the '6623A-150' selection, ratio of 20, a reversal rate of 60 seconds and a 'Test Current' of 150 mA as in 5.3.1. above.
4. Set the 6622A Comparator Bridge for 'MEAS ON'.
5. Measure and record the ohms value of the 9230A-30-0.1 Ω Shunt again and record the result. Only the last 35 measurement samples of a full stabilization period of 150 samples is to be used to determine the measurement value and associated standard deviation of the sample set.
6. Compare the result with the result of 5.3.1. The difference in the measurement values and is to be less than $\pm 0.92 \mu\Omega/\Omega$ when a 'B' or 'XR' 6622A Bridge is used and $\pm 0.72 \mu\Omega/\Omega$ when a 'XP', 'XPR' or 'HV' bridge is used to make the measurements.
7. Note that if the difference exceeds the limit, repeat the measurement in 5.3.1. and use the average of the two measured values in the comparison as a means for compensating for any temperature variations over the measurement period.

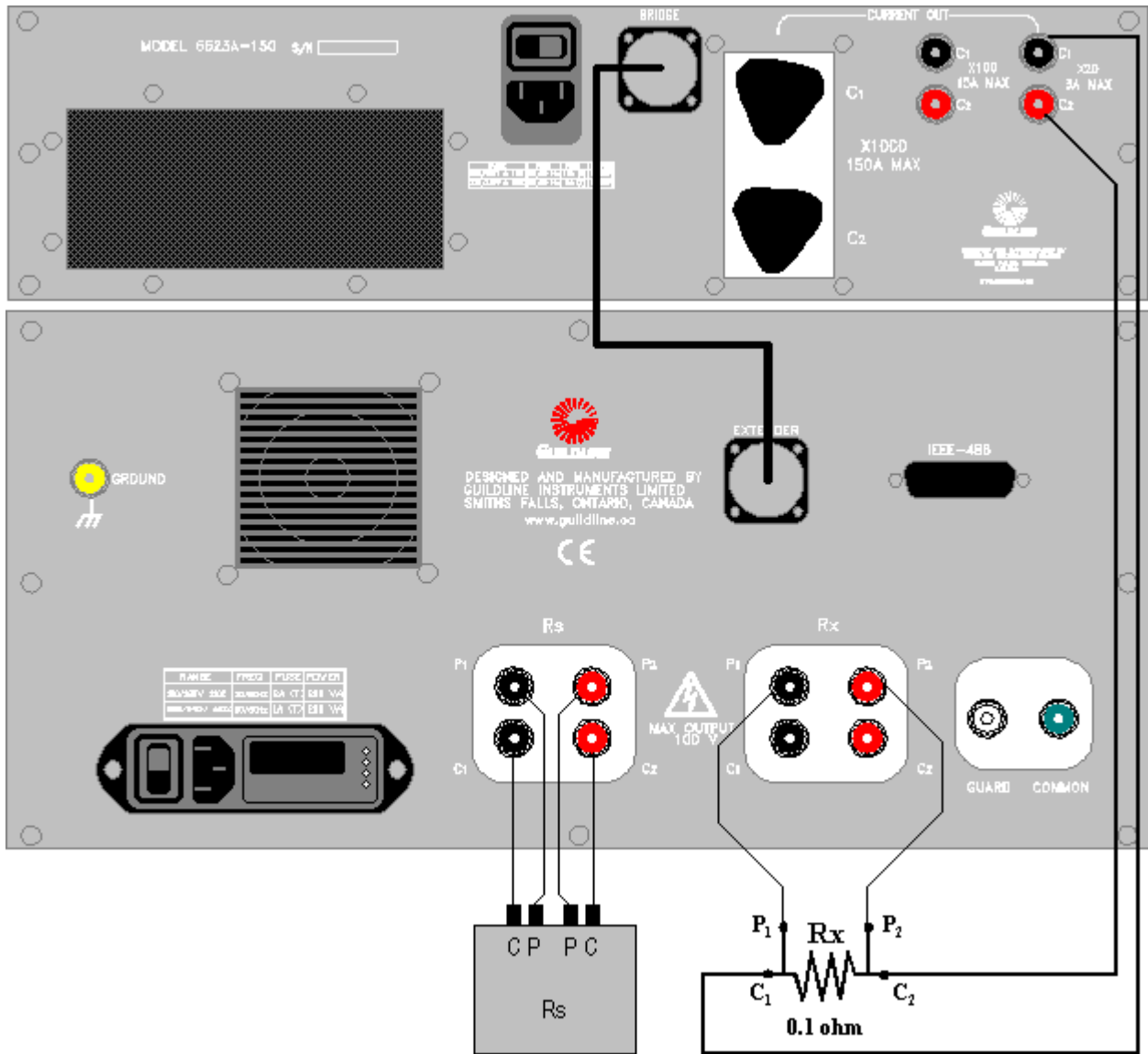

Figure 5-1 : Model 6623A-150 setup with Model 6622A, x20-3A Range

5.3.3. VERIFICATION OF THE x100-15A RATIO OF THE 6623A-150 RANGE EXTENDER

1. Replace the 9230A-30-0.1 Ω Shunt with the 9230A-100-0.01 Ω Shunt.
2. Measure and record the ohms value of the 9230A-100-0.01 Ω Shunt on the 6623A-150 Extender x20-3A range as in 5.3.2., but use a test current value of 3 A and a resistance value of 0.01 ohms. Only the last 35 measurement samples of a full stabilization period of 150 samples is to be used to determine the measurement value and associated standard deviation of the sample set.
3. Move the leads from the 6623A-150 Extender x20-3A range terminals to the x100-15A range terminals as shown in Figure 5-2.
4. Measure and record the ohms value of the 9230A-100-0.01 Ω Shunt again, but select the Extender Ratio value of 100 in the 6622A menu and a resistance value of 0.01 ohms and use a test current value of 3 A.
5. Compare the results in step 2 with step 4. The difference in the measurement values is to be less than $\pm 0.99 \text{ u}\Omega/\Omega$ when a 'B' or 'XR' 6622A Bridge is used and $\pm 0.85 \text{ u}\Omega/\Omega$ when a 'XP', 'XPR' or 'HV' bridge is used to make the measurements.
6. Note that if the difference exceeds the limit, repeat the measurement on the x20-3A range as in step 2 above and use the average of the two measured values in the comparison as a means for compensating for any temperature variations over the measurement period.
7. Note that the verification of the test current magnitudes of the x20-3A and the x100-15A ranges may be accomplished at this point by measurement of the voltage across the potential terminals of the shunt and calculating the test current value based on the measured resistance of the shunt over the range of test currents.

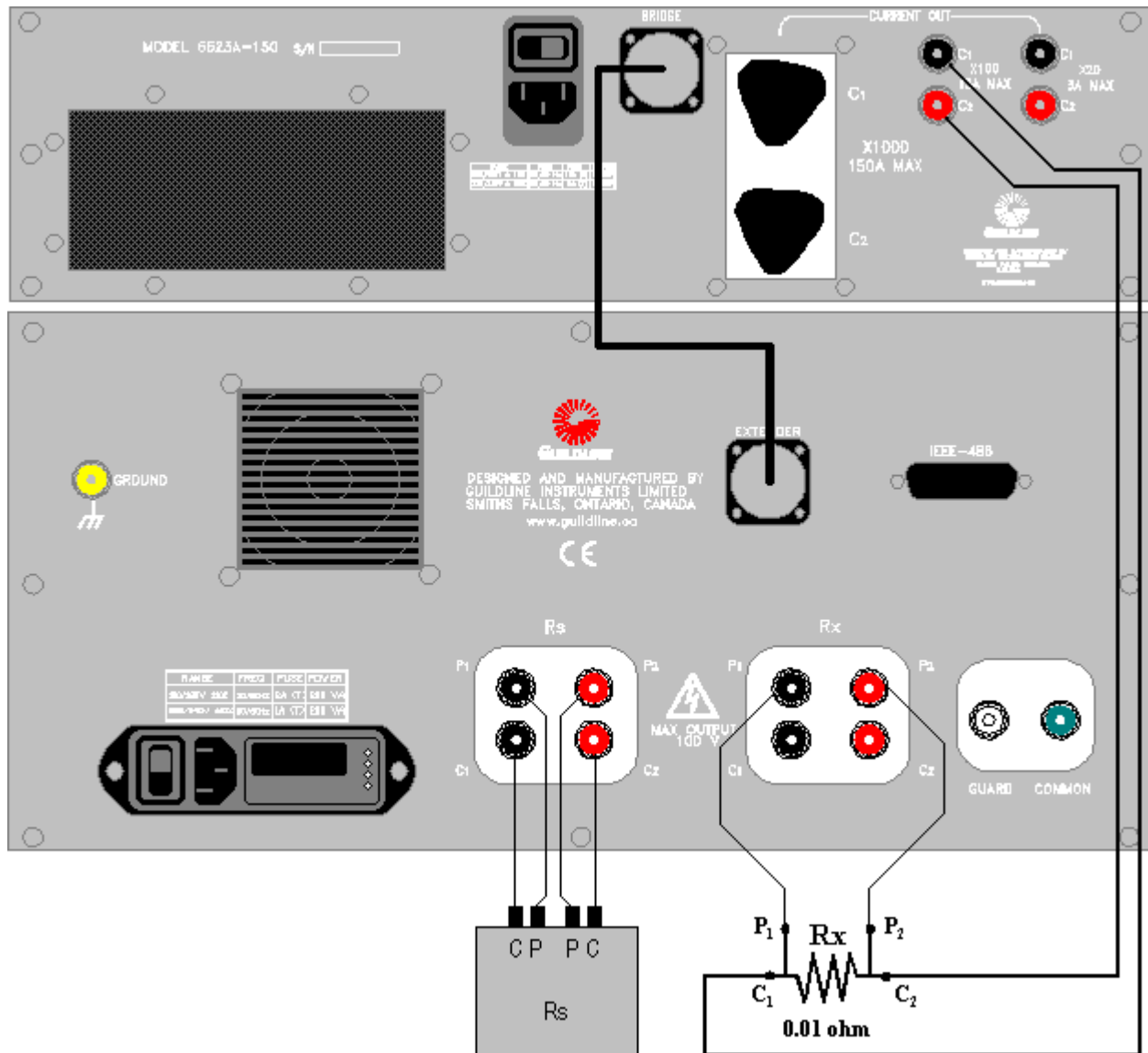

Figure 5-2 : Model 6623A-150 setup with Model 6622A, x100-15A Range

5.3.4. VERIFICATION OF THE x1000-150A RATIO OF THE 6623A-150 RANGE EXTENDER

1. Replace the 9230A-100-0.01 Ω Shunt with the 9230A-300-0.001 Ω Shunt.
2. Measure and record the ohms value of the 9230A-300-0.001 Ω Shunt on the 6623A-150 Extender x100-15A range as in 5.3.3., but use a test current value of 15 A and a resistance value of 0.001 ohms. Only the last 35 measurement samples of a full stabilization period of 150 samples is to be used to determine the measurement value and associated standard deviation of the sample set.
3. Move the leads from the 6623A-150 Extender x100-15A range terminals to the x1000-150A range terminals as in Figure 5-3.
4. Measure and record the ohms value of the 9230A-300-0.001 Ω Shunt again, but select the Extender Ratio value of 1000 in the 6622A menu and use a test current value of 15 A.
5. Compare the results of the two measurements. The difference in the measurement values is to be less than $\pm 1.06 \text{ u}\Omega/\Omega$ when a 'B' or 'XR' 6622A Bridge is used and $\pm 0.92 \text{ u}\Omega/\Omega$ when a 'XP', 'XPR' or 'HV' bridge is used to make the measurements.
6. Note that if the difference exceeds the limit, repeat the measurement on the x100-15A range and use the average of the two measured values in the comparison as a means for compensating for any temperature variations over the measurement period.
7. Note that the verification of the test current magnitudes of the x1000-150A range may be accomplished at this point by measurement of the voltage across the potential terminals of the shunt and calculating the test current value based on the measured resistance of the shunt over the range of test currents.

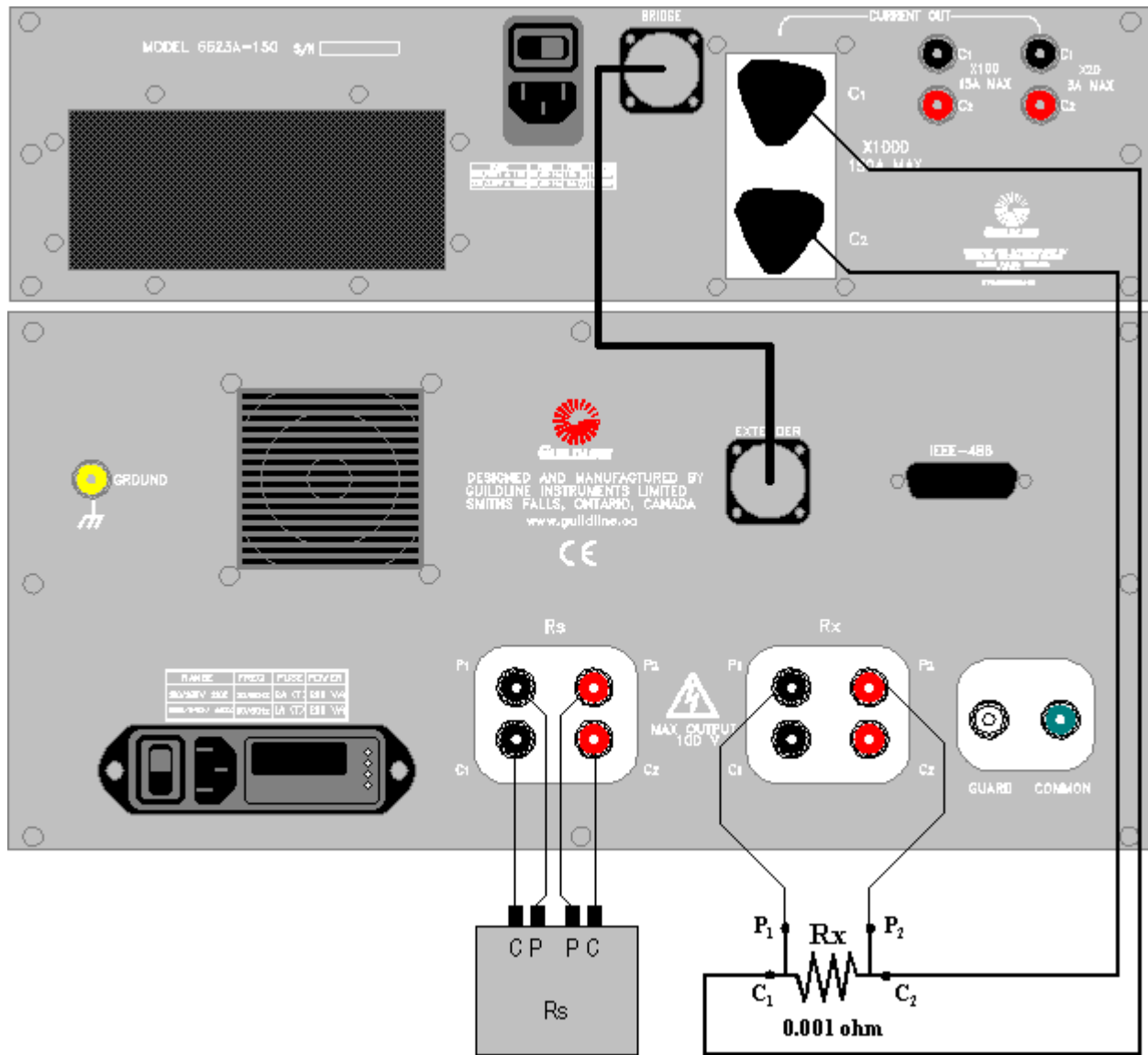

Figure 5-3 : Model 6623A-150 setup with Model 6622A, x1000-150A Range

6. TROUBLESHOOTING, MAINTENANCE AND CHECKS

6.1. INTRODUCTION

This section covers troubleshooting, repair, maintenance and checks of the 6623A-150 Current Range Extender.

6.1.1. Error Messages

The 6622A Automatic DCC Resistance Bridge will display error messages either on the front panel display of the 6622A Resistance Bridge in manual mode or on the computer monitor when using the BridgeWorks Data Acquisition Software. The error messages may relate to faulty operation or setup of the 6623A-150 High Current Range Extender. The error messages and their corrective measures are summarized in Table 6-1. See also the BridgeWorks Software User Manual for other related error messages that may be displayed. The 6622A will display the error messages until the next GPIB or keypad event. The BridgeWorks Data Acquisition Software will display the error messages until acknowledged by the user.

6.1.2. Model 6622A Setup Warnings

The Model 6622A Resistance Bridge provides limit checks for variables that can be setup during the configuration of a measurement including configuration of the Low Ohms mode using the 6623A-150 High Current Range Extender. Below is a listing of the warnings that may appear on its display in manual operation or on the computer monitor when the BridgeWorks Data Acquisition Software is used. Corrective measures can be made as appropriate before the measurement or other function is initiated. See also the BridgeWorks Software User Manual for other related error messages that may be displayed. The Model 6622A will display the warning messages until the next GPIB or keyboard event. The BridgeWorks Data Acquisition Software will display the warning messages until acknowledged by the user.

- Reversal Rate too low or not set!! Minimum reversal rate is 4 seconds!!
- Rs value has not been set!!
- Extender Ratio not set
- Test Value not set
- Max Test Value has not been set
- Test Value Exceeds Max Test Value
- Test Value Exceeds Maximum Current Output!!
- Test Value is below minimum current output!!!
- Maximum Current Value exceeds Maximum Current output!!!
- Set internal Values **“CAUTION: This menu allows full control of the Model 6622A and 6623A-150. Great care should be taken when using these functions.”**
- Self test not completed

Error Number	Error	Corrective Measures
0	nV Detector Communication Failure	None , fatal hardware error within the 6622A Bridge, (try power switch)
1	Invalid Test Setup	Resistors not wired to Rx and Rs terminals properly, improper test setup
2	Servo Railed	No current path on Rx or Rs terminals, improper connections or 6623A-150 failure
3	Nano Zero, nVoltmeter not responding	Cycle power switch, else fatal hardware error, 6622A failure
4	Null out of Range	Autoranger having problems, so enter in approximate ratio
5	Max Test Exceeded	Exceeded max current on Rx or Rs resistor
6	EEROM Failure, Resetting all values to default	Corrupted or lost stored configuration data in 6622A. You will need to reset your GPIB address to 4 (refer to 6622A Operation Manual, sections 4.6.6.1. and 6.1.3.) then run the 'Coefficient' utility located in the Utilities menu of the BridgeWorks Data Acquisition Software
7	Not implemented	
8	Nano Railed, Out of Nanovoltmeter range	Resistors not wired to Rx and Rs terminals properly, invalid Test setup
9	Failed Self Test	None , fatal 6622A power on error (try power switch)

Table 6-1 : Model 6622A And 6623A-150 Error Messages

Note: The 'Coefficient' utility described for error 6 is a dedicated program that can read in the stored ratio correction coefficients as well as load them into the 6622A Bridge. It can also store and load these values in a file as well as print them out. If error number 6 occurs, you should use this utility to verify that your 6622A has the proper coefficients loaded, by cross referencing them to the coefficient printout supplied with your system. If they are wrong, re-enter the correct values and update your 6622A Bridge to reflect these coefficients. This will return the bridge's alignment to the "as shipped" settings.

6.1.3. Fault Indication

The Fault indicator on the front panel will light up whenever a fault condition is detected in the 150 A current source of the range extender. This may be due to improper connections to the range extender, improper measurement setup or an actual circuit failure in the 6623A-150.

The fault may sometimes be cleared by cycling the power if the failure is not due to a circuit failure. Be sure that there is no shunt connected when cycling the power on the 6623A-150.

6.1.4. Maintenance

Preventive maintenance is limited to checking the instrument operation, ratio and test current accuracy and making sure that the air screens are clean. The air screens can be removed and cleaned as may be required. The cooling fan can be checked by verifying that there is air flow out of the air screen at the back panel.

The Service Manual, available on request from Guildline Instruments Limited, provides complete alignment, repair and test information required if the 6623A-150 fails to meet performance specifications in section 5.

6.1.5. Maintenance Guidelines and Schedule

The following section provides a guide to problem diagnosis and a schedule for maintenance. It is recommended that verification of the range extender be performed annually or whenever it is apparent that measurements may be out of specification. Under certain circumstances where verification fails then the range extender alignment should be checked and adjustments made as required. Specific verification procedures are provided in section 5 of this manual. Detailed alignment, repair and calibration procedures are found in the Service Manual.

Maintenance Item	Procedure	Interval
Measurement Error Messages	Follow guidelines in this section 6.1.1.	As may be required
System Setup Warnings	Follow guidelines in this section 6.1.2.	As may be required
Low Ohms Measurement Failures	Check cable/terminal connections, range extender fault indicator and perform range extender checks	As may be required
General Checks	Check cooling fans/screens and cable connections and fault indications	Every 3 months
Range Extender Accuracy	Perform Range Extender Verification	Annually
Range Extender Long Term Maintenance	Perform Range Extender Alignment Check and Calibration/Verification	Every 3 years

Table 6-2 : Maintenance Schedule

6.1.6. Connection Problems

Connection problems can be resolved by measuring the voltages on the potential terminals of the shunt resistance and that of the reference resistor and by observing the displayed test current on the bottom right of the bridge display.

Attach a suitable DVM to the bridge front panel RxP1 and RxP2 terminals. When initiating the measurement, observe that the RxP2 terminal voltage is positive with respect to the RxP1 terminal and is of a value equal to the test current times the shunt resistance value and agrees with the displayed value.

Also measure the voltage across the RsP1 and RsP2 terminals, while the bridge displayed current is still positive, and observe that the RsP2 terminal is also positive with respect to the RsP1 terminal and is approximately equal to that of the voltage on the shunt resistance.

If the polarity of the displayed current on the bridge is not initially positive this indicates a problem within the range extender internal connections. Contact Guildline Instruments to resolve this particular problem.

If the polarity on bridge Rx P terminals is not initially positive when the measurement is initiated, this indicates most likely an error has been made in connecting the current terminals of the shunt to the range extender C terminals or the potential terminals of the shunt to the bridge front panel Rx P terminals. Check the connections.

Similarly if the polarity of the Rs P terminals is not initially positive as well, there is most likely an error in the connections of the reference resistor to the bridge Rs terminals.

6.1.7. Safety Features

The 6622A Bridge will automatically prevent the initiation of a measurement or stop a measurement in progress and shut down the current source of the 6623A-150 when an error is detected.

7. APPENDICES

7.1. GENERAL SPECIFICATIONS

6623A-150 High Current Range Extender General Specifications		
Operating Temperature to Full Specification	+23 ± 3	°C
	+73 ± 5.4	°F
Operating Temperature Maximum Range <50% RH	+18 to +28	°C
	+64.4 to +82.4	°F
Storage Temperature Maximum Range	-20 to +60	°C
	-4 to +140	°F
Operating Humidity	20 to 70	% RH
Storage Humidity	15 to 80	% RH
Power Requirements (Maximum):	800	VA
Voltage Requirements (1)	100, 120, 220 or 240 ±10%	VAC
Line Frequency	50 ±5% or 60 ±5%	Hz
Weight (Nominal Bench Unit)	50/22.7	lbs/kg
Weight (Nominal Rack Unit)	46/21	lbs/kg
Dimensions (Bench Unit):	D 688 , W 445 , H 145	mm
	D 27.1 , W 17.5 , H 5.7	in
Dimensions (Rack Unit):	D 688 , W 526 , H 132	mm
	D 27.1 , W 20.7 , H 5.2	in

Table 7-1 : General Specifications

NOTE: 1. The 6623A-150 High Current Range Extender is always configured for 100 to 240 VAC 50/60 Hz operation at the point of shipment. No voltage selection is required in this range.

2. The correct fuse must be installed by the customer as per section 2.1.3.

3. Keep the 6623A-150 powered off when not in use for extended periods of time.

7.2. GENERAL SPECIFICATIONS (continued)

6623A-150 High Current Range Extender General Specifications (1 Year)			
Resistance Range		1 μ to 10	Ω
Transformation Ratios		20:1, 100:1, 1000:1	
Transformation Ratio Accuracies		$\pm 0.3, \pm 0.4, \pm 0.5$ ¹	ppm
Linearity		± 0.01	ppm of full scale ratio
Temperature Coefficient		± 0.01	ppm/ $^{\circ}$ C
Warm-up time to full rated accuracy		45	Minutes
Test Current Programmed through the 6622A Bridge	3A Range	± 0.1 to ± 3	A
	15A Range	± 3 to ± 15	A
	150A Range	± 15 to ± 150	A
	3A Compliance	± 5	V
	15A Compliance	± 7.5	V
	150A Compliance	± 1.5	V
	150A Power Limits	~ 240	W
	3A Accuracy	$\pm 0.1 \pm 0.4$ ¹	% + mA
	15A Accuracy	$\pm 0.3 \pm 5$	% + mA
	150A Accuracy	$\pm 0.3 \pm 30$	% + mA
	3A Stability (10 Min.)	$\pm 0.004 \pm 0.02$ ¹	% + mA
	15A Stability (10 Min.)	$\pm 0.005 \pm 0.5$	% + mA
150A Stability (10 Min.)	$\pm 0.005 \pm 1.0$	% + mA	

Note 1: Accuracies expressed as a total uncertainty with a coverage factor of k = 2.

Table 7-2 : General Specifications (continued)

7.3. RESISTANCE MEASUREMENT SPECIFICATION

The transformation ratio accuracies specified in Table 7-2 apply only to the range extender current division accuracy and do not apply to the overall resistance measurement accuracy as used with the 6622A Series of DCC Bridges.

Refer to the 6622A Operation Manual for the combined resistance measurement specification of the 6623A-150 with the 6622A Series of DCC Bridges in Low Ohms mode of operation. Resistance measurement accuracy varies with the various 6622A models.

7.4. CABLE CONNECTION DIAGRAMS

Connection of shunts with multiple connection points provides more consistent measurement values where multiple cable connections are used. The following diagrams illustrate a few connection methods where symmetry around the centre line of the shunt terminals is maintained. Cable lengths and size must be the same to achieve best results.

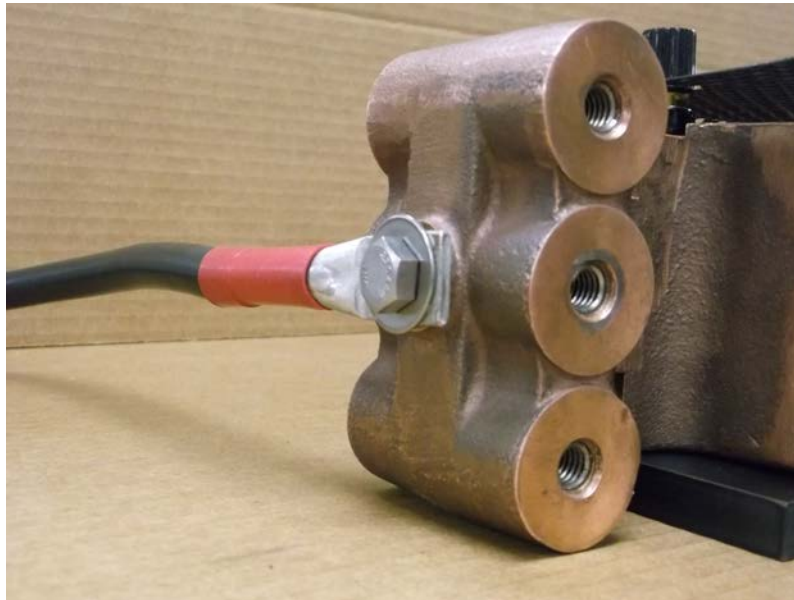

Figure 7-1 : Single Cable Connection

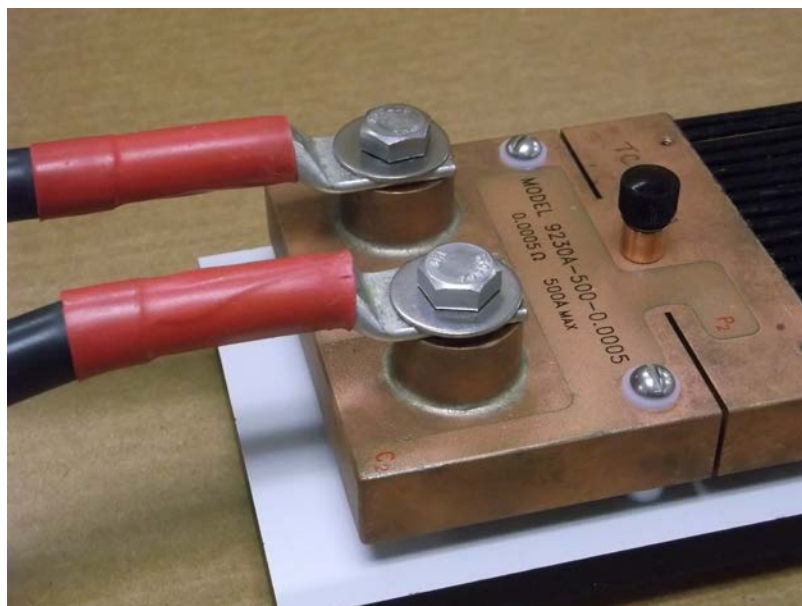

Figure 7-2 : Two Cable Horizontal Connection

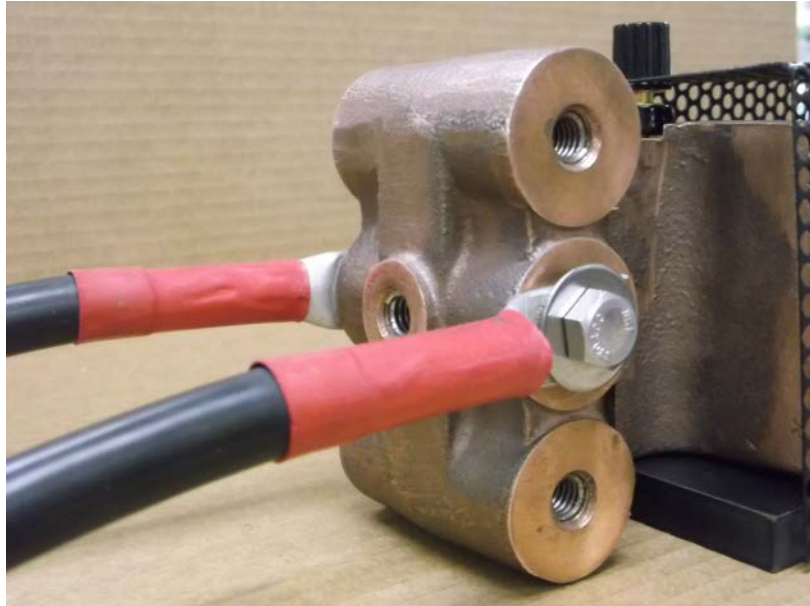

Figure 7-3 : Two Cable Vertical Connection