



**OPERATORS MANUAL**

**FOR**

**6530 SERIES**

**DIGITAL TERAOHM BRIDGE-METER**

**NOTICE**

The contents and information contained in this manual are proprietary to Guildline Instruments Limited. They are to be used only as a guide to the operation and maintenance of the equipment with which this manual was issued and may not be duplicated or transmitted by any means, either in whole or in part, without the written permission of Guildline Instruments Limited.

**OM6530-C4-00**  
**30 October, 2024**



# TABLE OF CONTENTS

<b>1. INTRODUCTION.....</b>	<b>1-1</b>
<b>1.1. FUNCTION DESCRIPTION .....</b>	<b>1-1</b>
1.1.1. PHYSICAL DESCRIPTION .....	1-2
1.1.2. PRINCIPLE OF OPERATION.....	1-3
1.1.3. MODES OF OPERATION.....	1-4
1.1.4. CIRCUIT DISCUSSION.....	1-5
<b>2. INSTALLATION.....</b>	<b>2-1</b>
<b>2.1. INSTALLATION .....</b>	<b>2-1</b>
<b>2.2. PRELIMINARIES .....</b>	<b>2-1</b>
<b>2.3. PRECAUTIONS .....</b>	<b>2-3</b>
<b>2.4. CONTROLS AND INDICATORS.....</b>	<b>2-3</b>
2.4.1. SWITCH FUNCTIONS.....	2-4
2.4.1.1. Rear Panel POWER Entry.....	2-4
2.4.1.2. Front Panel KEYPAD .....	2-4
2.4.1.3. Front Panel Menu Navigation Keys .....	2-4
2.4.1.4. Front Panel Programmable Function Keys.....	2-4
2.4.2. DISPLAY .....	2-4
2.4.3. CONNECTORS.....	2-4
2.4.3.1. SOURCE CONNECTOR.....	2-5
2.4.3.2. INPUT CONNECTOR.....	2-5
2.4.4. REAR PANEL CONTROLS.....	2-6
2.4.4.1. IEEE-488 INTERFACE.....	2-6
2.4.4.2. RS232 INTERFACE .....	2-6
2.4.4.3. Ground Terminal.....	2-6
2.4.4.4. PRESSURE .....	2-6
2.4.4.5. RH/TEMP .....	2-7
2.4.4.6. LINE INPUT CONNECTOR.....	2-7
2.4.4.7. EXTERNAL TRIGGER CONNECTOR .....	2-7
2.4.4.8. INTERLOCK CONNECTOR.....	2-7
<b>3. QUICK MEASUREMENT GUIDE .....</b>	<b>3-1</b>
<b>3.1. RESISTANCE MEASUREMENT.....</b>	<b>3-1</b>
3.1.1. RESISTANCE MEASUREMENT PROCEDURE .....	3-1
3.1.2. 2-TERMINAL RESISTANCE CONNECTION SCHEMATIC.....	3-2
3.1.3. 3-TERMINAL RESISTANCE CONNECTION SCHEMATIC.....	3-3
<b>3.2. BRIDGE VS DIRECT MEASUREMENT .....</b>	<b>3-4</b>
<b>3.3. CURRENT MEASUREMENT.....</b>	<b>3-7</b>
3.3.1. CURRENT MEASUREMENT PROCEDURE.....	3-7
3.3.2. CURRENT SOURCE CONNECTION SCHEMATIC .....	3-8

<b>4.</b>	<b>INSTRUMENT OPERATION .....</b>	<b>4-1</b>
<b>4.1.</b>	<b>BASIC MENU OPERATION.....</b>	<b>4-1</b>
4.1.1.	Menu System .....	4-1
4.1.2.	Key functions.....	4-1
4.1.2.1.	Navigation keys (up/down, left/right arrow) .....	4-2
4.1.3.	Select Mode .....	4-3
4.1.4.	Edit Mode .....	4-4
<b>4.2.</b>	<b>MAIN MENU.....</b>	<b>4-4</b>
<b>4.3.</b>	<b>Measurement Menu.....</b>	<b>4-5</b>
<b>4.4.</b>	<b>Ohms Measurement Menu .....</b>	<b>4-5</b>
4.4.1.	Ohms Setup.....	4-7
4.4.2.	Ohms Parameters Menu.....	4-9
4.4.3.	RESISTANCE, MANUAL RANGING .....	4-10
4.4.4.	Control Menu.....	4-12
4.4.5.	Trace .....	4-13
4.4.6.	Timers .....	4-14
4.4.7.	Profiles .....	4-14
4.4.8.	View.....	4-16
4.4.8.1.	Summary .....	4-16
4.4.8.2.	Detail Graph .....	4-17
4.4.8.3.	Detail .....	4-18
4.4.8.4.	Window .....	4-18
<b>4.5.</b>	<b>Current - MEASURING PICOAMPERES.....</b>	<b>4-19</b>
4.5.1.	AUTORANGING - Current .....	4-20
4.5.2.	MANUAL RANGING - Current .....	4-20
<b>4.6.</b>	<b>Surface Resistivity .....</b>	<b>4-22</b>
4.6.1.	Surface Resistivity Configure .....	4-23
<b>4.7.</b>	<b>Volume Resistivity .....</b>	<b>4-23</b>
4.7.1.	Volume Resistivity Thickness Setup .....	4-24
4.7.2.	Volume Resistivity Configure .....	4-24
<b>4.8.</b>	<b>Configure.....</b>	<b>4-25</b>
4.8.1.	GPIB .....	4-26
4.8.2.	RS232 .....	4-27
4.8.3.	Sensors .....	4-28
4.8.4.	Sys Time .....	4-28
<b>4.9.</b>	<b>Sofcal.....</b>	<b>4-28</b>
4.9.1.	User.....	4-29
4.9.1.1.	Calibration Coefficients .....	4-29
4.9.1.2.	Self Test .....	4-30
4.9.2.	Calibrate.....	4-31
4.9.2.1.	Utilities.....	4-31
4.9.2.2.	Calibration Coefficient Values.....	4-36
4.9.2.3.	Reference Values.....	4-39
4.9.2.4.	Sensors .....	4-43

4.9.3.	Diagnostics .....	4-45
4.9.3.1.	Digital PS .....	4-45
4.9.3.2.	Analog PS.....	4-46
4.9.3.3.	Relay Test.....	4-46
4.9.3.4.	Voltage Test .....	4-46
4.9.3.5.	External Input.....	4-47
4.9.3.6.	DAC7548 Calibrate.....	4-47
4.9.4.	Password.....	4-47
<b>4.10.</b>	<b>Menu System Hierarchy Diagrams.....</b>	<b>4-48</b>
<b>5.</b>	<b>REMOTE CONTROL.....</b>	<b>5-1</b>
<b>5.1.</b>	<b>INTERFACES.....</b>	<b>5-1</b>
<b>5.2.</b>	<b>IEEE-488 (GPIB) INTERFACE.....</b>	<b>5-1</b>
5.2.1.	CONTROLLER.....	5-2
5.2.2.	IEEE-488 RESPONSES .....	5-2
5.2.3.	INTERCONNECTING CABLE AND IEEE-488 CONNECTOR.....	5-2
5.2.4.	TYPICAL SYSTEM.....	5-2
5.2.5.	ADDRESS AND TALK/LISTEN SELECTION.....	5-3
5.2.6.	IEEE-488 ELECTRICAL INTERFACE .....	5-3
5.2.7.	IEEE-488 INPUT BUFFERING.....	5-4
5.2.8.	IEEE-488 OUTPUT BUFFERING.....	5-4
5.2.9.	IEEE-488 DEADLOCK .....	5-5
<b>5.3.</b>	<b>RS-232C INTERFACE.....</b>	<b>5-5</b>
5.3.1.	RS-232C RESPONSES .....	5-6
<b>5.4.</b>	<b>COMMAND LANGUAGE.....</b>	<b>5-6</b>
5.4.1.	GENERAL SYNTAX FOR COMMANDS .....	5-6
5.4.2.	GENERAL SYNTAX FOR NUMBERS.....	5-7
5.4.3.	REMOTE AND LOCAL OPERATION.....	5-7
5.4.4.	LOCAL.....	5-7
5.4.5.	REMOTE.....	5-8
5.4.6.	REMOTE WITH LOCKOUT.....	5-8
<b>5.5.</b>	<b>PROGRAMMING COMMAND SUMMARY.....</b>	<b>5-9</b>
5.5.1.	Standard System Commands .....	5-10
5.5.2.	Calibration Commands .....	5-12
5.5.3.	Configuration Commands.....	5-13
5.5.4.	Measurement Commands .....	5-13
5.5.5.	Trace Commands.....	5-15
5.5.6.	Trigger Commands .....	5-16
<b>5.6.</b>	<b>REMOTE COMMANDS.....</b>	<b>5-17</b>
5.6.1.	*CLS - CLEAR STATUS COMMAND .....	5-17
5.6.2.	*ESE <u> - SET EVENT STATUS ENABLE REGISTER.....	5-17
5.6.3.	*ESE? - EVENT STATUS ENABLE QUERY .....	5-17
5.6.4.	*ESR? - EVENT STATUS REGISTER QUERY .....	5-17
5.6.5.	*IDN? - IDENTIFICATION QUERY .....	5-18
5.6.6.	*OPC - OPERATION COMPLETE.....	5-18
5.6.7.	*OPC? - OPERATION COMPLETE QUERY .....	5-18
5.6.8.	*OPT? - REPORT AVAILABLE OPTIONS.....	5-19
5.6.9.	*RST - DEVICE RESET .....	5-19

5.6.10.	*SRE <u> - SERVICE REQUEST ENABLE COMMAND .....	5-19
5.6.11.	*SRE? - SERVICE REQUEST ENABLE QUERY .....	5-19
5.6.12.	*STB? - STATUS BYTE QUERY .....	5-19
5.6.13.	*TST? - QUERY RESULTS OF SELF TEST.....	5-20
5.6.14.	*WAI - WAIT-TO- CONTINUE COMMAND .....	5-21
5.6.15.	SYSTem:ATMospheric:PRESSure? – DISPLAY ATMOSPHERIC PRESSURE .....	5-21
5.6.16.	SYSTem:CHECK:SUM? – DISPLAY CHECKSUMS.....	5-21
5.6.17.	SYSTem:COMMunications:GPIB – UPDATE GPIB CONFIG .....	5-21
5.6.18.	SYSTem:COMMunications:GPIB?.....	5-21
5.6.19.	SYSTem:COMMunications:SERial .....	5-21
5.6.20.	SYSTem:COMMunications:SERial?.....	5-22
5.6.21.	SYSTem:DATE – UPDATE SYSTEM DATE .....	5-22
5.6.22.	SYSTem:DATE? – DISPLAY SYSTEM DATE .....	5-22
5.6.23.	SYSTem:HUMidity? – DISPLAY HUMIDITY.....	5-22
5.6.24.	SYSTem:KEY? – DISPLAY LAST KEY STROKE.....	5-22
5.6.25.	SYSTem:MODE – SET SYSTEM MODE.....	5-22
5.6.26.	SYSTem:MODE? – DISPLAY SYSTEM MODE .....	5-22
5.6.27.	SYSTem:SERial:NUMBer – SET SYSTEM SERIAL NUMBER.....	5-22
5.6.28.	SYSTem:SERial:NUMBer? – DISPLAY SYSTEM SERIAL NUMBER .....	5-23
5.6.29.	SYSTem:STATe - UPDATE SYSTEM STATE .....	5-23
5.6.30.	SYSTem:STATe? – DISPLAY SYSTEM STATE.....	5-23
5.6.31.	SYSTem:TEMPerature? – DISPLAY TEMPERATURE.....	5-23
5.6.32.	SYSTem:TERSe – SET SYSTEM TO TERSE .....	5-24
5.6.33.	SYSTem:TIME – SET SYSTEM TIME.....	5-24
5.6.34.	SYSTem:TIME? – DISPLAY SYSTEM TIME .....	5-24
5.6.35.	SYSTem:VERSion? – DISPLAY SYSTEM VERSION .....	5-24
5.6.36.	SYSTem:VERBoSe – SET SYSTEM TO VERBOSE.....	5-24
5.6.37.	CALibration:CAPacitor – UPDATE COEFFICIENT .....	5-24
5.6.38.	CALibration:CAPacitor? – DISPLAY COEFFICIENTS .....	5-24
5.6.39.	CALibration:DATE – UPDATE LAST CALIBRATION DATE .....	5-24
5.6.40.	CALibration:DATE? – DISPLAY LAST CALIBRATION DATE.....	5-25
5.6.41.	CALibration:OUTPut:VOLTage – UPDATE COEFFICIENTS .....	5-25
5.6.42.	CALibration:OUTPut:VOLTage? – DISPLAY COEFFICIENTS .....	5-25
5.6.43.	CALibration:PARAmeters:PROTection .....	5-25
5.6.44.	CALibration:PARAmeters:PROTection? .....	5-25
5.6.45.	CALibration:PARAmeters:RESistor .....	5-26
5.6.46.	CALibration:PARAmeters:RESistor?.....	5-26
5.6.47.	CALibration:PROTection:RESistor .....	5-26
5.6.48.	CALibration:PROTection:RESistor?.....	5-27
5.6.49.	CALibration:REFerence:RESistor .....	5-27
5.6.50.	CALibration:REFerence:RESistor? .....	5-27
5.6.51.	CALibration:SERial:NUMBer.....	5-27
5.6.52.	CALibration:SERial:NUMBer?.....	5-27
5.6.53.	CALibration:SPEC:CLEar .....	5-27
5.6.54.	CALibration:SPEC?.....	5-27
5.6.55.	CALibration:SYSTem:COEFFicient .....	5-27
5.6.56.	CALibration:SYSTem:COEFFicient? .....	5-28
5.6.57.	CALibration:SYSTem:PARAmeters .....	5-28
5.6.58.	CALibration:SYSTem:PARAmeters?.....	5-28
5.6.59.	CALibration:SYSTem:REV .....	5-28
5.6.60.	CALibration:SYSTem:REV?.....	5-28
5.6.61.	CALibration:THREshold:VOLTage.....	5-28
5.6.62.	CALibration:THREshold:VOLTage?.....	5-28
5.6.63.	CONFigure:TEST:VOLTage.....	5-28
5.6.64.	MEASure – START/STOP MEASUREMENT .....	5-29
5.6.65.	MEASure?.....	5-29

5.6.66.	MEASure:UNITS – SET CURRENT MEASUREMENT MODE .....	5-29
5.6.67.	MEASure:UNITS? – DISPLAY MEASUREMENT MODE .....	5-29
5.6.68.	READ:RESistance? .....	5-29
5.6.69.	READ:CURRent? .....	5-29
5.6.70.	READ:SURFace:RESistivity? .....	5-29
5.6.71.	READ:VOLume:RESistivity? .....	5-29
5.6.72.	SENSe:ATMospheric:PRESSure? .....	5-29
5.6.73.	SENSe:CAPacitor – SET CURRENT CAPACITOR .....	5-29
5.6.74.	SENSe:CAPacitor? – DISPLAY CURRENT CAPACITOR.....	5-30
5.6.75.	SENSe:HUMidity?.....	5-30
5.6.76.	SENSe:INTEgration:TIME?.....	5-30
5.6.77.	SENSe:INTEGrator:THRESHold.....	5-30
5.6.78.	SENSe:INTEgrator:THRESHold? .....	5-30
5.6.79.	SENSe:MAXimum:VOLTage .....	5-30
5.6.80.	SENSe:MAXimum:VOLTage? .....	5-30
5.6.81.	SENSe:OUTput:VOLTage .....	5-30
5.6.82.	SENSe:OUTput:VOLTage?.....	5-30
5.6.83.	SENSe:POLarity .....	5-30
5.6.84.	SENSe:POLarity .....	5-31
5.6.85.	SENSe:RANGe.....	5-31
5.6.86.	SENSe:RANGe? .....	5-31
5.6.87.	SENSe:REMote:INTErlock.....	5-31
5.6.88.	SENSe:REMote:INTErlock? .....	5-31
5.6.89.	SENSe:RESistivity:THICKness .....	5-31
5.6.90.	SENSe:RESistivity:THICKness?.....	5-31
5.6.91.	SENSe:RESistivity:AREA.....	5-31
5.6.92.	SENSe:RESistivity:AREA?.....	5-31
5.6.93.	SENSe:RESistivity:PERimeter .....	5-32
5.6.94.	SENSe:RESistivity:PERimeter? .....	5-32
5.6.95.	SENSe:RESistivity:DISTance .....	5-32
5.6.96.	SENSe:RESistivity:DISTance?.....	5-32
5.6.97.	SENSe:TEMPerature? .....	5-32
5.6.98.	TRACe:CLEar – CLEAR DETAIL TRACE BUFFER .....	5-32
5.6.99.	TRACe:DATA? – DUMP TRACE BUFFER.....	5-32
5.6.100.	TRACe:DIAGnostics .....	5-33
5.6.101.	TRACe:DIAGnostics? .....	5-33
5.6.102.	TRACe:MODE .....	5-33
5.6.103.	TRACe:MODE? .....	5-33
5.6.104.	TRACe:ELEMents.....	5-33
5.6.105.	TRACe:ELEMents? .....	5-33
5.6.106.	TRACe:TREND:DATA? – DUMP SUMMARY BUFFER.....	5-33
5.6.107.	TRACe:TREND:SUM? - DUMP SUMMARY STATISTICS.....	5-33
5.6.108.	TRACe:TREND:CLEar – CLEAR SUMMARY STATISTICS .....	5-33
5.6.109.	TRACe:TSTamp:TYPE .....	5-34
5.6.110.	TRACe:TSTamp:TYPE? .....	5-34
5.6.111.	TRIGger:SOURce.....	5-34
5.6.112.	TRIGger:SOURce? .....	5-34
5.6.113.	TRIGger:DELAy .....	5-34
5.6.114.	TRIGger:DELAy?.....	5-34
5.6.115.	TRIGger:SOAK .....	5-34
5.6.116.	TRIGger:SOAK? .....	5-35
5.6.117.	TRIGger:SENSor:TIMer .....	5-35
5.6.118.	TRIGger:SENSor:TIMer?.....	5-35

<b>6.</b>	<b>VERIFICATION AND CALIBRATION .....</b>	<b>6-1</b>
<b>6.1.</b>	<b>CALIBRATION DESCRIPTION.....</b>	<b>6-1</b>
6.1.1.	ENVIRONMENTAL CONDITIONS.....	6-1
6.1.2.	INITIAL CONDITIONS .....	6-1
6.1.3.	RECOMMENDED TEST EQUIPMENT.....	6-1
6.1.4.	CHECK CALIBRATION REPORT.....	6-1
6.1.4.1.	CALIBRATION COEFFICIENTS .....	6-2
6.1.5.	TEST VOLTAGE VERIFICATION .....	6-2
6.1.6.	OPERATIONAL CHECK.....	6-3
<b>6.2.</b>	<b>CALIBRATION PROCEDURE .....</b>	<b>6-3</b>
6.2.1.	ENVIRONMENTAL CONDITIONS.....	6-3
6.2.2.	INITIAL CONDITIONS .....	6-3
6.2.3.	RECOMMENDED TEST EQUIPMENT.....	6-4
6.2.4.	OUTPUT VOLTAGE CALIBRATION.....	6-4
6.2.5.	AUTO CALIBRATION .....	6-5
6.2.6.	CAPACITOR CALIBRATION.....	6-7
6.2.7.	THRESHOLD CALIBRATION.....	6-8
6.2.8.	ZERO COEFFICIENT CALIBRATION.....	6-9
<b>6.3.</b>	<b>CALIBRATION REPORT .....</b>	<b>6-10</b>
<b>6.4.</b>	<b>CALIBRATION THEORY .....</b>	<b>6-12</b>
6.4.1.	R <sub>protection</sub> COEFFICIENT .....	6-12
6.4.2.	V <sub>test</sub> COEFFICIENTS .....	6-12
6.4.3.	C <sub>integrator</sub> COEFFICIENTS.....	6-13
6.4.4.	T <sub>integrator</sub> COEFFICIENTS.....	6-13
<b>7.</b>	<b>TROUBLE SHOOTING AND MAINTENANCE.....</b>	<b>7-1</b>
7.1.	PREVENTATIVE MAINTENANCE.....	7-1
7.2.	NON VOLATILE MEMORY CHECKSUM.....	7-2
7.3.	TROUBLESHOOTING .....	7-2
7.4.	ERROR MESSAGES.....	7-3
<b>8.</b>	<b>APPENDICES.....</b>	<b>8-1</b>
8.1.	GENERAL SPECIFICATIONS.....	8-1
8.2.	RESISTANCE MEASUREMENT SPECIFICATIONS .....	8-2
8.3.	PICOAMMETER MEASUREMENT SPECIFICATIONS .....	8-3
8.4.	RESOLUTION .....	8-3
8.5.	SYSTEM PARAMETER.....	8-4
8.6.	SAMPLE BUS CONTROL PROGRAM.....	8-7



<b>8.7.</b>	<b>MEASUREMENT TECHNIQUE.....</b>	<b>8-10</b>
8.7.1.	LARGE VALUE RESISTOR MEASUREMENT TECHNIQUE.....	8-10
8.7.2.	ENVIRONMENT .....	8-10
8.7.3.	SAMPLE PREPARATION .....	8-10
8.7.4.	TEST LEAD ROUTING .....	8-10
8.7.5.	CAPACITIVE TEST SAMPLES .....	8-10
<b>8.8.</b>	<b>OTHER FEATURES .....</b>	<b>8-11</b>
<b>8.9.</b>	<b>ACCESSORY EQUIPMENT .....</b>	<b>8-12</b>
8.9.1.	Environmental Monitor Model 65220 .....	8-12
8.9.1.1.	Humidity .....	8-12
8.9.1.2.	RH Sensor Specification .....	8-12
8.9.1.3.	Precision Centigrade Temperature Sensor .....	8-13
8.9.1.4.	Pressure Sensor .....	8-13
8.9.1.5.	Integrated Pressure Sensor Specifications.....	8-13
8.9.2.	Surface/Volume Resistivity Test Fixture Model 65221.....	8-14
8.9.3.	Calibration Resistors.....	8-14
8.9.4.	Small Shielded Enclosure .....	8-16
8.9.5.	Large Shielded Enclosure .....	8-16
8.9.6.	Lead Set Model 65225 .....	8-16
8.9.7.	Calibration Kit Model 65226.....	8-17
8.9.8.	Zero Link Model 65224.....	8-17
8.9.9.	IEEE Interface Accessories.....	8-17
8.9.10.	6530/RC Report of Calibration .....	8-17
8.9.11.	6564 High Resistance Scanner.....	8-17



# LIST OF FIGURES

<b>FIGURE 1-1: 6530 FRONT PANEL</b> .....	1-2
<b>FIGURE 1-2: 6530 REAR PANEL</b> .....	1-2
<b>FIGURE 1-3: 6530 SIMPLIFIED BLOCK DIAGRAM</b> .....	1-3
<b>FIGURE 1-4: 6530 OPERATIONAL INTEGRATOR</b> .....	1-6
<b>FIGURE 2-1: OPENING THE POWER RECEPTACLE</b> .....	2-2
<b>FIGURE 2-2: 6530 FRONT PANEL</b> .....	2-3
<b>FIGURE 2-3: 6530 FRONT PANEL CONNECTORS</b> .....	2-4
<b>FIGURE 2-4: 6530 REAR PANEL CONNECTORS</b> .....	2-6
<b>FIGURE 2-5: TYPICAL EXTERNAL TRIGGER CIRCUITS</b> .....	2-8
<b>FIGURE 2-6: TYPICAL INTERLOCK CIRCUIT CONFIGURATION</b> .....	2-8
<b>FIGURE 3-1: 2-TERMINAL RESISTANCE MEASUREMENT SCHEMATIC</b> .....	3-2
<b>FIGURE 3-2: 3-TERMINAL RESISTANCE MEASUREMENT SCHEMATIC</b> .....	3-3
<b>FIGURE 3-3: CURRENT SOURCE MEASUREMENT SCHEMATIC</b> .....	3-8
<b>FIGURE 4-1: OHMS HIERARCHY</b> .....	4-49
<b>FIGURE 4-2: CURRENT HIERARCHY</b> .....	4-50
<b>FIGURE 4-3: RESISTIVITY HIERARCHY</b> .....	4-51
<b>FIGURE 4-4: SETUP HIERARCHY</b> .....	4-52
<b>FIGURE 4-5: SOFCAL HIERARCHY</b> .....	4-53
<b>FIGURE 4-6: SOFCAL CAL. VALS. HIERARCHY</b> .....	4-54
<b>FIGURE 4-7: SOFCAL DIAGNOSTIC HIERARCHY</b> .....	4-55
<b>FIGURE 5-1 : EVENT STATUS BIT OPERATION</b> .....	5-16



# LIST OF TABLES

<b>TABLE 2-1: POWER FUSE SELECTION</b> .....	2-2
<b>TABLE 5-1 : IEEE-488 DEVICE CAPABILITIES</b> .....	5-3
<b>TABLE 5-2 : IEEE-488 PIN DESIGNATIONS</b> .....	5-4
<b>TABLE 5-3 : RS232 PIN DESIGNATIONS</b> .....	5-5
<b>TABLE 5-4 : REMOTE/LOCAL STATE TRANSITIONS</b> .....	5-8
<b>TABLE 5-5 : EVENT STATUS REGISTER</b> .....	5-18
<b>TABLE 5-6 : STATUS BYTE REGISTER</b> .....	5-20
<b>TABLE 6-1: RECOMMENDED VERIFICATION TEST EQUIPMENT</b> .....	6-1
<b>TABLE 6-2: RECOMMENDED CALIBRATION TEST EQUIPMENT</b> .....	6-4
<b>TABLE 6-3: SAMPLE CALIBRATION REPORT FORMAT</b> .....	6-11
<b>TABLE 8-1: GENERAL SPECIFICATIONS</b> .....	8-1
<b>TABLE 8-2: RESISTANCE MEASUREMENT UNCERTAINTY</b> .....	8-2
<b>TABLE 8-3: CURRENT MEASUREMENT UNCERTAINTY (ALL MODELS)</b> .....	8-3
<b>TABLE 8-4: MEASUREMENT RESOLUTIONS (DIGITS)</b> .....	8-3
<b>TABLE 8-5: DEFAULT SYSTEM PARAMETER</b> .....	8-6
<b>TABLE 8-6: CALIBRATION RESISTORS</b> .....	8-15
<b>TABLE 8-7: IEEE INTERFACES</b> .....	8-17



## 1. INTRODUCTION

This manual provides complete information on the installation and operation of the Guildline Instruments Model 6530 Digital TeraOhm Bridge-Meter. Also included is a general description of the theory of operation together with instructions for calibration. The TeraOhm Bridge-Meter is based on fundamental work performed by Dr. S. H. Tsao of the National Research Council of Canada, and is manufactured by Guildline Instruments.

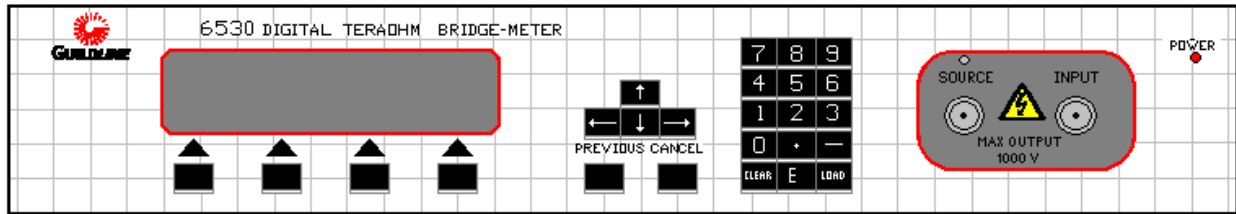
### 1.1. FUNCTION DESCRIPTION

The Guildline Model 6530 TeraOhm Bridge-Meter is a microprocessor based, fully automated, high precision device for measuring high value resistances or very small DC currents. It combines the proven technology of previous Guildline Teraohmmeters (i.e. Models 9520, 6500, and 6520) with the latest in measurement circuitry and microprocessor technology. In bridge operation, fully automated intercomparisons between multiple resistance standards of different nominal values can be achieved using the 6564 High Resistance Scanner. For installation instructions, refer to Section 2.

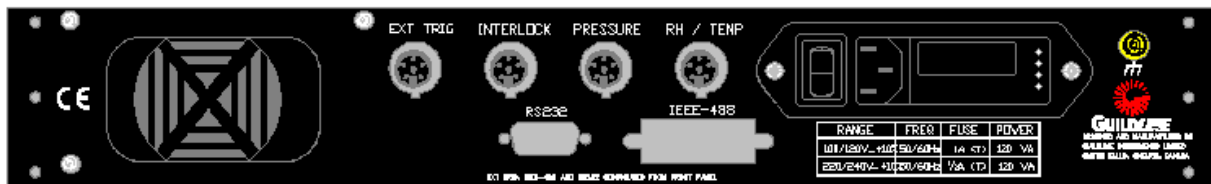


The main features of the model 6530 are:

- Direct reading operation with no external references required
- Bridge measurement operation allowing transfers from reference artifacts.
- Auto ranging from 90 k $\Omega$  to 20 P $\Omega$ .
- Auto ranging from 10 mA to 100 fA.
- Built in GPIB and RS-232C interfaces.
- Fully controllable through the bus interfaces.
- Internal software routines for measurement error compensation.
- Extensive self-diagnostics.
- User-friendly interface.



**Figure 1-1: 6530 Front Panel**

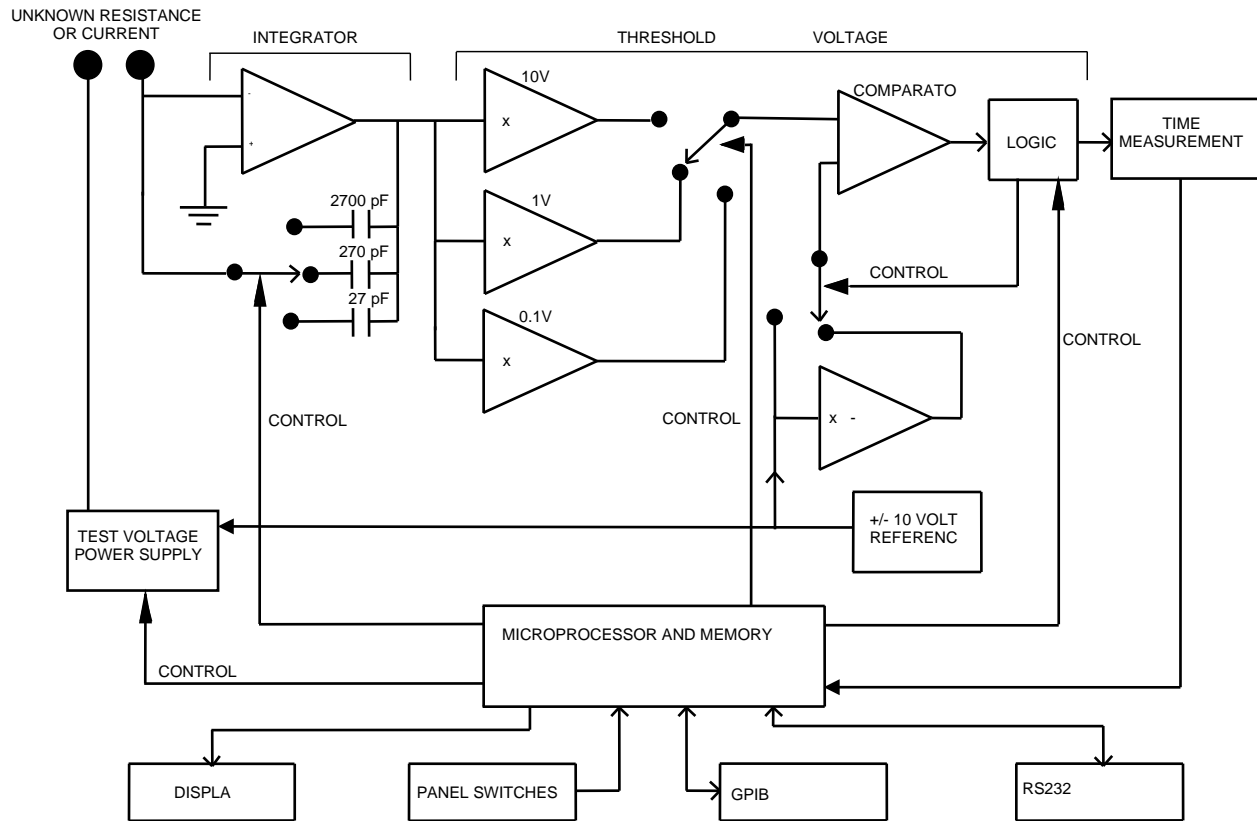


**Figure 1-2: 6530 Rear Panel**

### 1.1.1. PHYSICAL DESCRIPTION

The Guildline 6530 Digital TeraOhm Bridge-Meter is housed in a steel case for reduction of electromagnetic emissions in compliance with CE standards, and to protect the measurement circuitry from EMI. All indicators and frequently used controls are located on the front panel together with two connectors for connection of the unknown resistor or current. The power connection is made through a detachable 3-conductor power cord, which plugs into the rear panel. Although the instrument is primarily intended for bench top use, front panel flanges are supplied to allow it to be mounted in a standard 19-inch cabinet.





**Figure 1-3: 6530 Simplified Block Diagram**

### 1.1.2. PRINCIPLE OF OPERATION

The simplified block diagram of Figure 1-3 details the major components of the TeraOhm Bridge-Meter.

When measuring resistance, a known DC test voltage is supplied by the 6530, which causes a current to flow through the unknown resistor into an integrator. The magnitude of this current is determined by the time required for the integrator output to pass between two different threshold voltage points. Knowing the test voltage and magnitude of the current, the microprocessor can determine the value of the unknown resistor. The test voltage is selectable from 7 standard values in the range  $\pm (1 \text{ to } 1000) \text{ DC V}$ . The standard values are:  $\pm (1; 3; 10; 30; 100; 300; 1000) \text{ DC V}$ . Custom voltage values can be provided upon request.

Unknown currents can be measured by connecting the unknown current source output directly to the integrator input (the internal test voltage source is not used when measuring currents).

The stability of the Model 6530 depends on the stability of the applied test voltage, the integrator, the timing circuit and the threshold voltage detector at the integrator output. The fixed deviations in the absolute values of these parameters are compensated during calibration by using a software calibration routine in conjunction with a set of external calibration resistors of known value. Guildline manufactures 9336 and 9337 calibration resistors that are ideally suited for this purpose. Guildline also manufactures a 6636 Temperature Stabilized Resistor set that is suited to calibrate the 6530 in environments where the temperature is not regulated to laboratory standards.

The Model 6530 is fully automated with an internal microprocessor to compute the measurements and make the deviation compensations. The microprocessor can be operated from the front panel manual controls or from either one of the two communication control buses. The calculated value of the unknown resistor is displayed on the front panel and is made available to instruments attached to either control bus. The Model 6530 provides increased accuracy through integrated filtering options and taking measurements with test voltage polarity alterations. The computed average is displayed on the front panel and is made available to instruments on the control bus (GPIB or RS-232C).

### **1.1.3. MODES OF OPERATION**

The Model 6530 is fully automated for simplicity and convenience. When specific measurement parameters are required the operator (or instruments on the control bus) can manually configure the 6530.

The instrument can be set to take a continuous series of measurements or to take one measurement for each sample request. A sample request can be made with an external synchronizing signal fed to a rear panel connector or by the operator pressing a front panel function key/push-button.

The number of resistance measurements made per data sample output (averaged), is user selectable. The resistance test voltage polarity is selectable. When measuring current, both polarities can also be accommodated by this selection.

The SOFCAL (software calibration) function permits the operator to calibrate the instrument and edit the calibration date and the serial number of the instrument.

## 1.1.4. CIRCUIT DISCUSSION

The Model 6530 TeraOhm Bridge-Meter measures high values of resistance by charging a small capacitor through the resistance to be measured. An operational integrator is shown in Figure 1-4. The equations for this integrator are as follows:

$$\frac{\Delta V_{out}(t)}{\Delta t} = \frac{V_{in}}{R \times C} \quad \begin{array}{l} \text{(The equality is not exact} \\ \text{but is extremely close when} \\ \text{the voltage gain is high)} \end{array} \quad (1)$$

or:

$$R = \frac{V_{in} \times \Delta t}{C \times \Delta V_{out}} \quad (2)$$

Where  $\Delta t$  = a change in time and  $\Delta V_{out}$  = a change in output voltage  $V_{out}$  over time  $\Delta t$ .

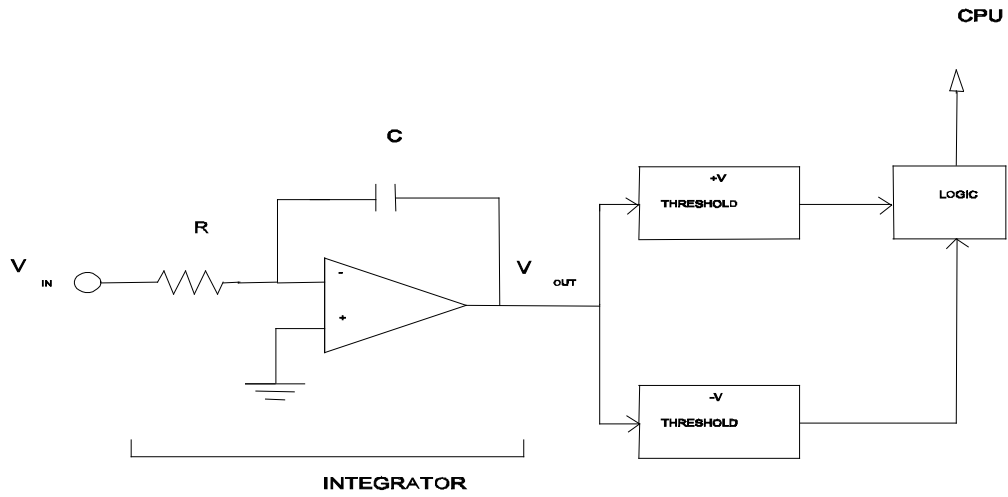
When current is being measured,  $V_{in}$  can be replaced by  $iR$  which simplifies (1) to the form:

$$i = \frac{C \times \Delta V_{out}}{\Delta t} \quad (3)$$

In the Model 6530:

- \*  $V_{in}$  is the test voltage for resistance measurement.
- \*  $C$  is a stable capacitor selected from the nominal values of 27 pF, 270 pF or 2700 pF.
- \*  $\Delta V_{out}$  is the potential difference between two threshold voltages placed symmetrically above and below ground ( $V_{out} = 2V_{thresh}$  where  $V_{thresh}$  is selectable from 0.1 volt, 1 volt or 10 volts).

In equations (2) and (3), all terms are constant except  $R$ ,  $i$  and  $\Delta t$ . Therefore  $\Delta t$  is proportional to  $R$  or inversely proportional to the current  $i$ . During normal operation the 6530 calculates the unknown resistance  $R$  or current  $i$  by taking measurements of the time  $\Delta t$ .



**Figure 1-4: 6530 Operational Integrator**

## 2. INSTALLATION

### 2.1. INSTALLATION

This instrument was thoroughly tested and inspected before shipment and should be free from damage when received. Inspect it carefully, verify that all items on the packing list are present and check the instrument operation as soon as possible. Refer to the warranty card at the front of this manual if any damage or deficiencies are found.

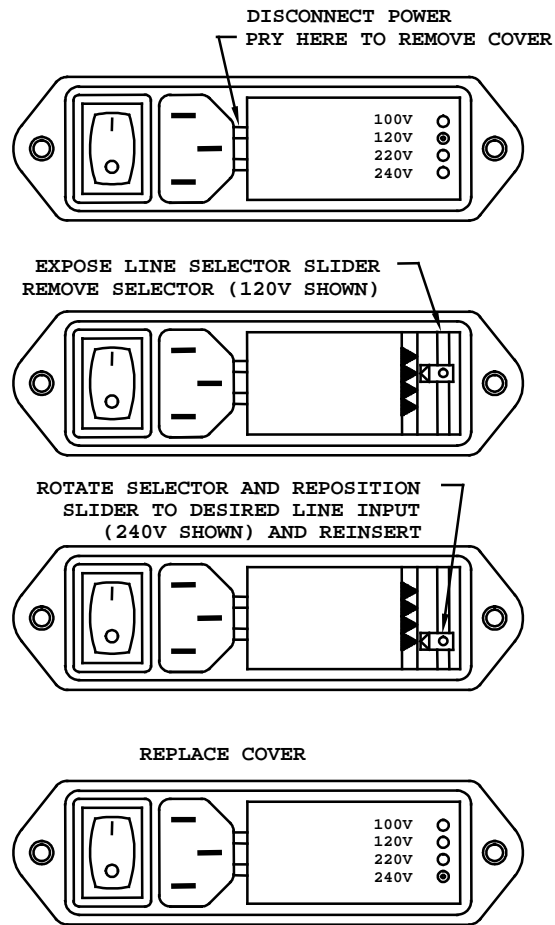
The 6530 TeraOhm Bridge-Meter is an instrument intended to be used in a laboratory environment and is specified to be operated within an environmental temperature range of  $23^{\circ}\text{C} \pm 5^{\circ}\text{C}$  with humidity levels in the range  $40\% \text{ rH} \pm 10\% \text{ rH}$ . Optimum performance is achieved when the environmental temperature range is  $(23 \pm 2)^{\circ}\text{C}$ . Higher humidity can degrade the accuracy of the instrument. The 6530 must be mounted with an angle of inclination of no more than  $30^{\circ}$ . Where the TeraOhm Bridge-Meter is to be used in a rack, attach the mounting brackets provided. To attach the rack mounting flanges (brackets), the original screws holding the handles to the instrument are removed and the flanges attached over the handles with the longer screws supplied. The instrument has to be supported in the rack/cabinet with adjustable support angles or a support bar. In case of interference with other equipment mounted directly below the instrument, the 4 feet must be removed. Install the unit in the rack.

### 2.2. PRELIMINARIES

The model 6530 has been shipped with the line input voltage set to 240 volts with the fuse removed. The line input selectors must be set to the correct line voltage before power is applied to the instrument. Remove the warning label positioned across the power entry only after setting the proper operating voltage. The line input voltage selection must be set correctly. The settings available are 100 V, 120 V, 220 V, and 240 V. Figure 2-1 details the line input voltage selector.

The instrument is supplied with a North American style line cord, unless otherwise specified at time of order. Ensure that the line cord is plugged into a wall socket or extension cord that has a protective or safety ground. Where 3-contact power supply outputs are not available, a suitable protective ground connection must be made before switching the instrument power on. Any interruption of the protective ground may possibly render the instrument unsafe.

To set the correct line input voltage open the power receptacle on the rear panel as shown in Figure 2-1.



**Figure 2-1: Opening the Power Receptacle**

Check to see that the fuses inserted in the receptacle correspond to the correct type specified in Table 2-1.

Line Voltage	Fuse Type Required
100 V 120 V	2 Amp (T) (MDL_2A/250 V)
220 V 240 V	1 Amp (T) (MDL-1A/250 V)

**Table 2-1: POWER FUSE SELECTION**

Only fuses of the specified type are to be used. Set the voltage selector drum so that the proper line voltage indication will be visible through the receptacle rear window when the receptacle

cover is closed. This is important because the drum selects the proper transformer connection for the required voltage.

The supplied molded line cord should be plugged into the 3-pin power receptacle on the rear panel of the instrument. Plug the line cord into a receptacle with the required voltage and a protective ground connection. A ferrite sleeve (part no. 060-13229) is provided with the Spare Parts. This sleeve should be installed over the line cord to reduce electromagnetic emissions.

Where the molded plug on the supplied line cord does not match the power outlet receptacle the plug may be removed and replaced with a 3-pin plug of the correct type.

The plug should be wired as follows:

- Brown - Line voltage
- Blue - Neutral
- Green/Yellow - Ground (Earth)

### 2.3. PRECAUTIONS

The instrument should be disconnected from the line supply before any attempt is made to remove the cover. Lethal voltages are present at several points within the instrument and under some operating conditions at the source connector. **Therefore ONLY QUALIFIED PERSONNEL WHO ARE AWARE OF THE NECESSARY PRECAUTIONS SHOULD BE GIVEN ACCESS TO THIS EQUIPMENT.**

Operation of the instrument with the cover removed will result in degraded performance due to the lack of shielding from radiated electrical interference.

### 2.4. CONTROLS AND INDICATORS

The front panel of the 6530 TeraOhm Bridge-Meter, as shown in Figure 2-2, has a prominent 256 by 64 dot vacuum fluorescent graphic display, which provides a visual readout of data and status. Four momentary action programmable function keys located below the display window combine to provide complete user control and functionality of the 6530. A conventional 3 column by 5 row keypad matrix provides user entry of the digits 0,1,2,3,4,5,6,7,8,9,-, and (.). In addition, a set of keys labelled “CLEAR”, “E”, “LOAD”, with cursor movement keys Up Arrow, Down Arrow, Left Arrow, Right Arrow and menu control keys “PREVIOUS” and “CANCEL”, allow for operator navigation through the set-up and operation of the 6530.

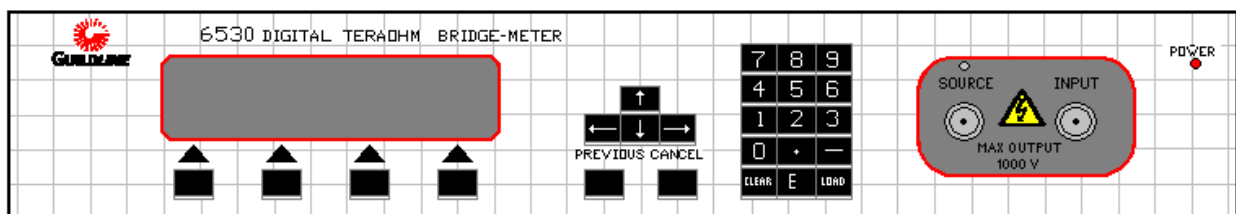


Figure 2-2: 6530 Front Panel

## 2.4.1. SWITCH FUNCTIONS

### 2.4.1.1.Rear Panel POWER Entry

The on/off toggle switch is the only function that cannot be controlled by the GPIB and RS-232C bus interfaces.

### 2.4.1.2.Front Panel KEYPAD

The keypad consists of a 3 key by 5 key momentary switch arrangement that allows entry of a numeric sequence (0, 1, 2, 3, 4, 5, 6, 7, 8, 9). Additional keys in the keypad layout allow for the selection of decimal point “.”, minus “-“, “CLEAR”, exponent “E” and “LOAD” functions.

### 2.4.1.3. Front Panel Menu Navigation Keys

Two momentary action keys labeled “PREVIOUS” and “CANCEL” allow the operator to move between menu levels of the 6530.

### 2.4.1.4.Front Panel Programmable Function Keys

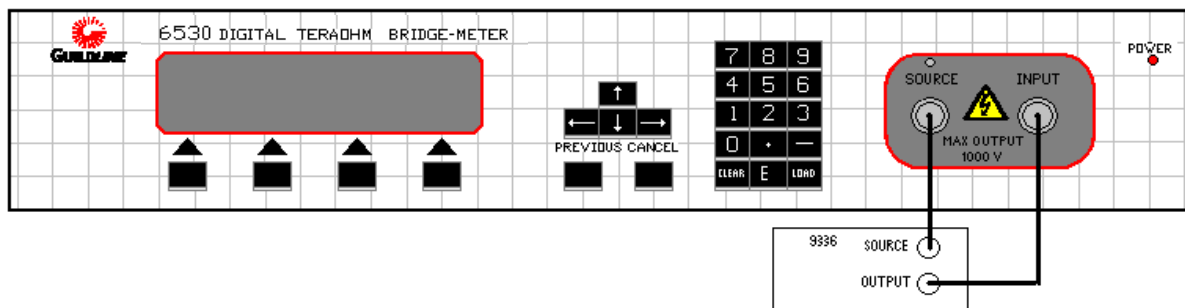
This series of four momentary action keys allow for the selection of any one of 4 software-controlled actions. The action available for each function key is displayed in the display directly above the key.

## 2.4.2. DISPLAY

The main display is a 256 by 64 dot vacuum-fluorescent graphic display that shows the measured data and provides system level information to the operator during the measurement cycle(s), as well as the software calibration and system initialization procedures.

## 2.4.3. CONNECTORS

Two connectors are mounted to the front panel for attachment of the resistance or current under test (see Figure 2-3 6530 Front Panel Terminals). The connectors are labeled “SOURCE” and “INPUT”.



**Figure 2-3: 6530 Front Panel Connectors**



### **2.4.3.1.SOURCE CONNECTOR**

Lethal voltages of up to 1000 volts may be present at this output and appropriate precautionary measures are necessary. **UNQUALIFIED OR UNINFORMED PERSONNEL SHOULD NOT BE GIVEN ACCESS TO THIS EQUIPMENT.**

The selected voltage is present at the center conductor of the high voltage BNC connector whenever the TEST VOLTS display indicates its numeric value and the LED above the source connector is illuminated. While the source can only generate three or four milliamperes at a steady rate, the output filter capacitors, can produce considerably greater currents for short periods of time. The SOURCE cable provided with the 6530 is HV BNC at the instrument end and Type-N at the U.U.T. end to provide direct connection with Guildline 9336 and 9337 series resistors. Other connector end cables are available as an option.

### **2.4.3.2.INPUT CONNECTOR**

The sensitivity and very high impedances (100k ohm) at this connector require careful handling. Large static discharges to this connector should be avoided. One terminal of the unknown resistance or current is connected to the center conductor of the triax connector. The INPUT cable provided with the 6530 is Triax at the instrument end and Type-N at the U.U.T. end to provide direct connection with out 9336 and 9337 series resistors. Other connector end cables are available as an option.

## 2.4.4. REAR PANEL CONTROLS

Rear Panel controls are shown in Figure 2-4.



**Figure 2-4: 6530 Rear Panel Connectors**

### 2.4.4.1. IEEE-488 INTERFACE

The **IEEE-488** interface consists of the standard **IEEE-488** interface connector. The **IEEE-488** interface provides the means for a computer system to obtain complete control of the 6530. Computer control can be implemented through the use of the included TeraCal software package (part no. 30052-01-33), or through IEEE-488 compliant software that utilizes the 6530 remote command set. A Service Manual (SM6530) is available which details all of the remote commands. A ferrite sleeve (part no. 060-13231) is provided with the Spare Parts. This sleeve should be installed over the IEEE-488 cable to reduce electromagnetic emissions. IEEE interface adaptors and cables can be obtained through Guildline Instruments Limited, See Section 8.9.9 to determine which one is right for you.

### 2.4.4.2. RS232 INTERFACE

The **RS232** interface consists of the standard **RS232 DB9** interface connector. The **RS232** interface provides the means for a computer system to obtain complete control of the 6530. Computer control can be implemented through a standard **RS232** terminal program or **RS232** based software that utilizes the 6530 remote command set. A Service Manual (SM6530) is available which details all of the remote commands. A ferrite sleeve (part no. 060-13229) is provided with the Spare Parts. This sleeve should be installed over the RS232 cable to reduce electromagnetic emissions.

### 2.4.4.3. Ground Terminal

The ground terminal consists of a single binding post. The ground terminal is bonded to the chassis of the model 6530 and to power ground of the line input connector.

### 2.4.4.4. PRESSURE

A 5-pin DIN connector provides the input connection for the Guildline Absolute Pressure Environmental sensor (part no. 65220).

### **2.4.4.5.RH/TEMP**

A 5-pin DIN connector provides the input connection for the Guildline combined %Relative Humidity and Temperature Environmental sensor (part no. 65220).

### **2.4.4.6.LINE INPUT CONNECTOR**

The **Line Input Connector** is a combination of a 3-prong AC standard male connector, an ON/OFF switch and a fused input line voltage selector. The input line's voltage selector consists of a four-position selector and a fuse holder. The selector allows switching between the four possible settings: 100V, 120V, 220V and 240V. A 2 Amp time delay fuse is provided for the 100/120 V operation and a 1 Amp time delay fuse is provided for the 220/240 V operation. The voltage selector and fuse are set for the 240V operation at the factory (see Section 2.2)

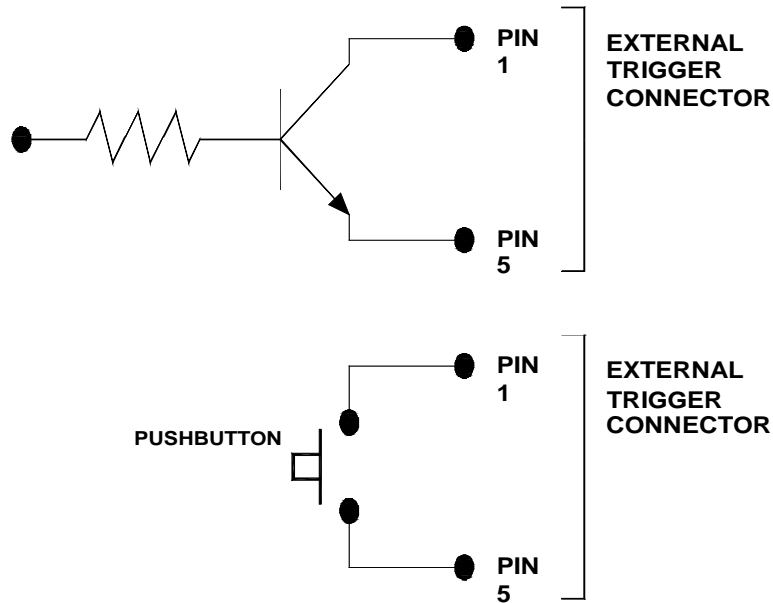
### **2.4.4.7.EXTERNAL TRIGGER CONNECTOR**

This rear panel connector shown in Figure 2-4 works when the TRIGGER SOURCE is set to external (See Section 4.4.4) to initiate a measurement each time the EXT TRIG signal pin in the connector is grounded. Internally, the signal pin (pin 1) of the connector is supplied with +5V through an LED and a 330 Ohm resistor. Figure 2-5 shows typical external trigger circuits.

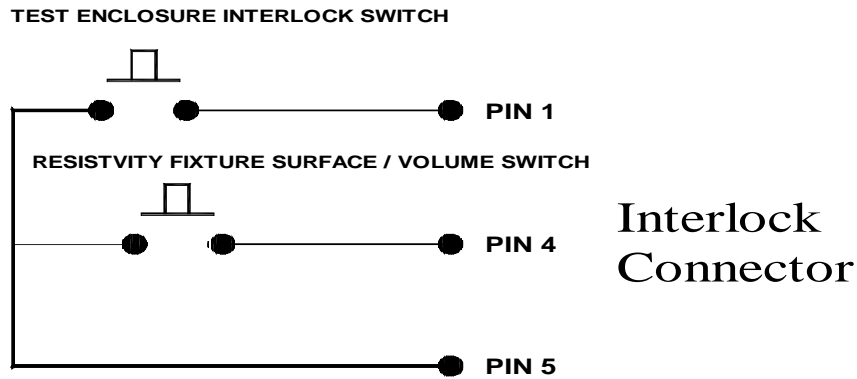
### **2.4.4.8.INTERLOCK CONNECTOR.**

This rear panel connector, shown in Figure 2-4 is a dual function connector containing an interlock control and a Resistivity test fixture Surface/Volume selection indicator signal.

The interlock control and test fixture status interface connections can be wired externally as shown in Figure 2-6 for typical Interlock Circuit Configurations.



**Figure 2-5: Typical External Trigger Circuits**



**Figure 2-6: Typical Interlock Circuit Configuration**

### 3. QUICK MEASUREMENT GUIDE

The 6530 although having many features and functions allowing in depth control of the measurement process, has been designed for ease of use. The Auto ranging and Auto reverse functions are enabled by default and are the best choice in most applications. This section outlines the basic measurement procedure using this mode of operation. The advanced measurement options and features are all outlined in remaining sections of this manual.

#### 3.1. RESISTANCE MEASUREMENT

Most high and ultra-high value resistors come as a 2 or 3 terminal device. An example of each are the Guildline model 9336 resistor which is a 2-terminal device, and a model 9337 which is a 3-terminal device. The measurement procedure for both the 9336 and 9337 is identical. They both have a “Source” and an “Output” connector. The “Source” (voltage in) connector of the resistor should be connected to the “Source” (voltage out) connector of the 6530. Note that the center pin is the applied voltage with respect to the outer shield (chassis ground).

**Note: Lethal voltages of up to 1000 volts may be present at this output and appropriate precautionary measures are necessary.**

The “Output” (current out) connector of the resistor should be connected to the “Input” (current in) connector of the 6530. Note that the center pin is the return current with respect to the outer shield (chassis ground). The inner shield (electrometer ground) is shorted to the outer shield to allow for a common reference to the internal voltage supply. Refer to Figures 3-1 and 3-2.

##### 3.1.1. RESISTANCE MEASUREMENT PROCEDURE

To make a resistance measurement, do the following steps.

1. Connect the unknown resistance device.
2. Select the <Measure> function key in the **Main Menu**
3. Select the <Ohms> function key in the **Measure Option Menu**
4. Select the <Setup> function key in the **Measure Ohms Menu**
5. Select the <Parameters> function key in the **Ohms Setup Menu**
6. Select the <Max Volts> function key in the **Ohms Parameters Menu**
7. Select the “Previous” key twice to return to the **Measure Ohms Menu**
8. Select the <Start> function key to initiate the measurement cycle.
9. The 6530 will proceed to determine the correct range and take continuous measurements.

### 3.1.2. 2-TERMINAL RESISTANCE CONNECTION SCHEMATIC

Outlined below is an example of a typical 2-terminal resistance device connected to the 6530. Note that the known voltage is dropped on the U.U.T. resistor element and the resultant current is returned to the electrometer to be measured. The resistance is determined by the measured current and known voltage.

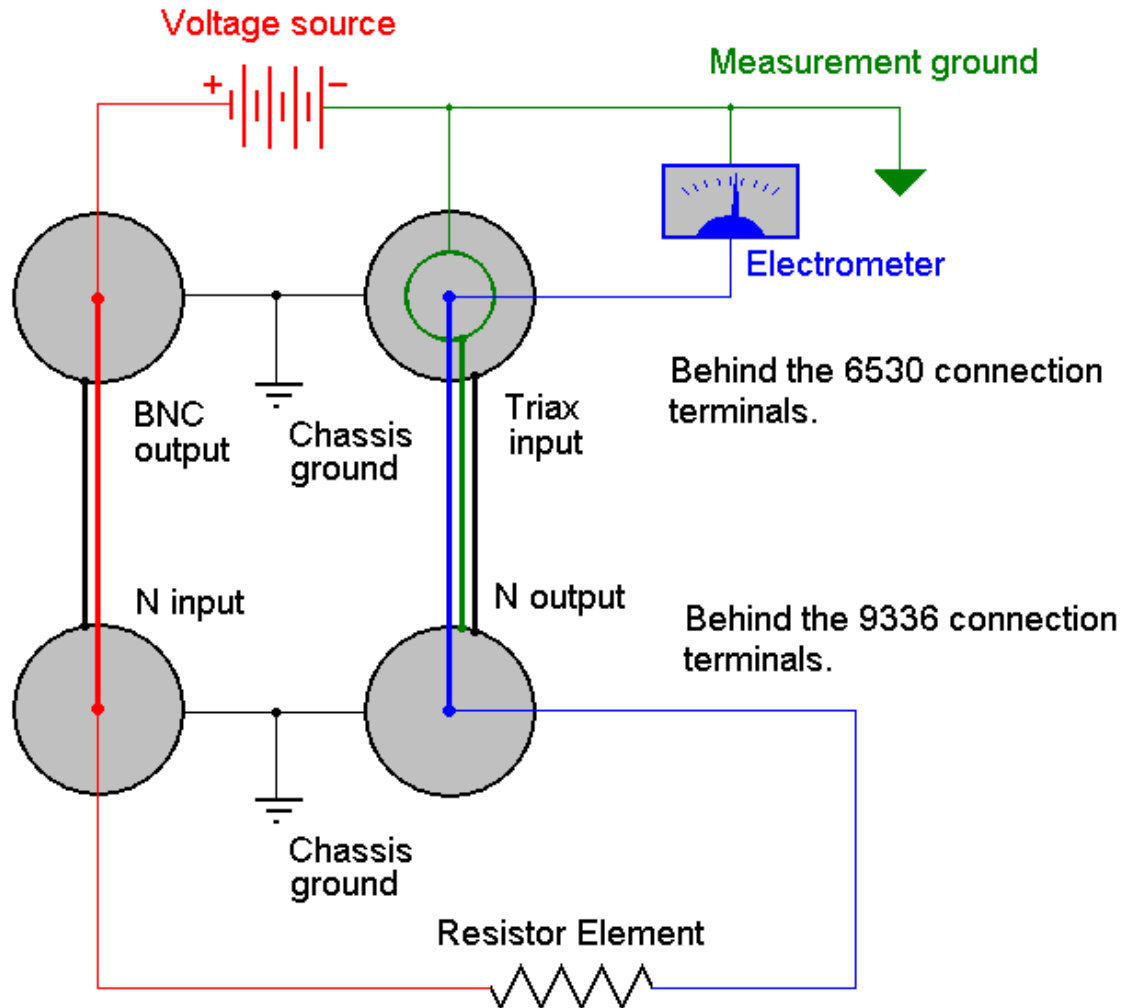


Figure 3-1: 2-Terminal Resistance Measurement Schematic

### 3.1.3. 3-TERMINAL RESISTANCE CONNECTION SCHEMATIC

Outlined below is an example of a typical 3-terminal resistance device connected to the 6530. Note that the known voltage is dropped on the U.U.T. resistor elements and the resultant current is ratio divided and partially returned to the electrometer to be measured. The effective resistance is determined by the measured return current and known voltage.

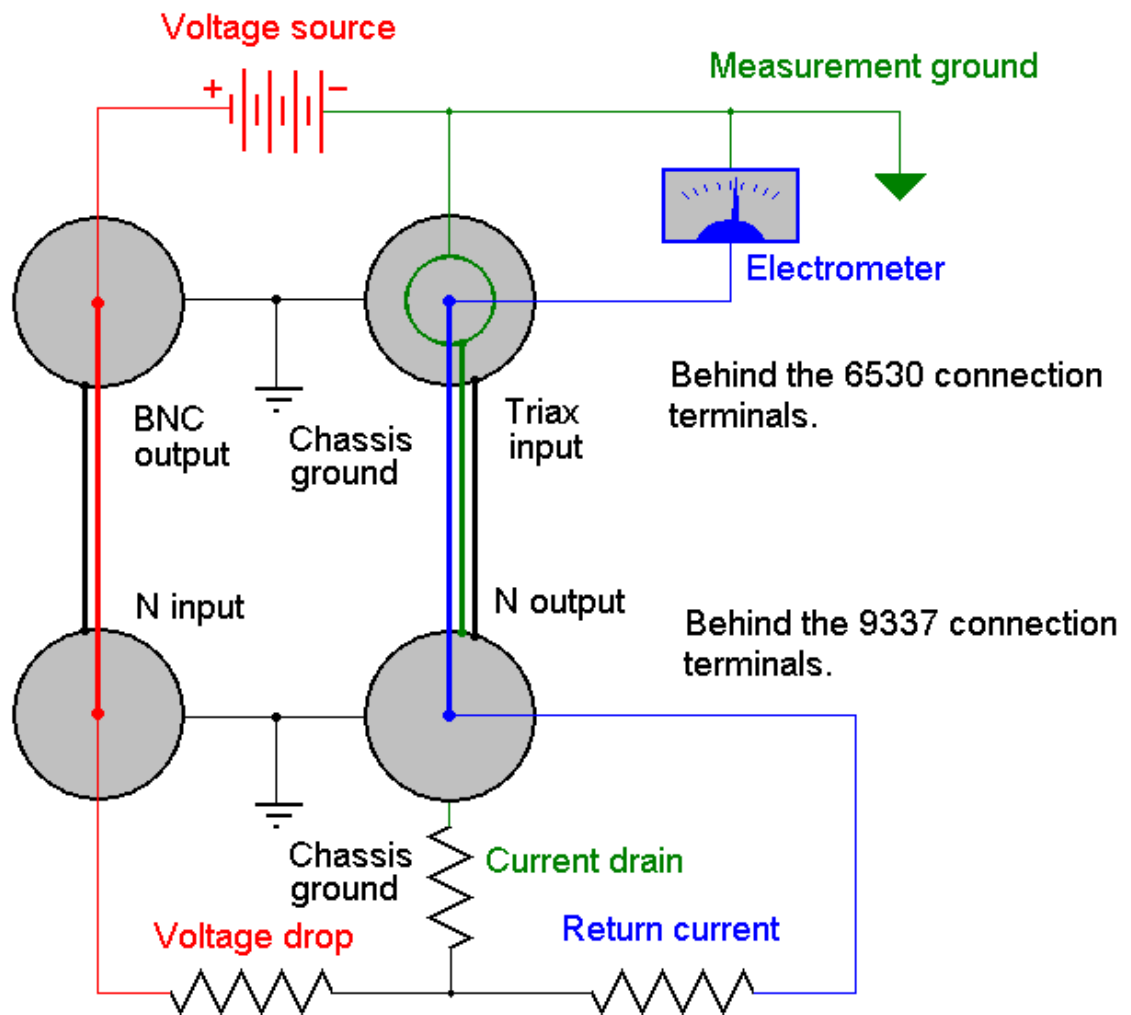


Figure 3-2: 3-Terminal Resistance Measurement Schematic

### 3.2. BRIDGE VS DIRECT MEASUREMENT

Two measurement methods are available to perform resistance measurements using a Guildline 6530 High Resistance Bridge-Meter. One method is simply to directly measure the resistance of the unit under test (UUT) and take the published or previously calibrated long-term measurement uncertainty of the 6530 High Resistance Bridge-Meter. The second, more accurate, method is to use the bridge method. In the bridge method, the resistance of the UUT is measured and compared with and shortly after a known resistance standard has been measured by the same high resistance meter, as follows.

When using the bridge method always use the best reference resistance standards available to the operator as the uncertainties of the reference will determine your baseline uncertainty. When measuring a resistance value using bridge method, you should have both resistors housed in the shielded enclosure together, to avoid delays waiting for the UUT to stabilize after measuring the resistance standard. Keep the measurement cycle times longer rather than shorter, as speeding up a measurement will result in more noise. However, the operator must not take too long a measurement (too many samples), as this will allow more time for the meter and resistance standards to drift. A good practice is to take 300 samples using the last 100 for the mean and standard deviation. The operator must ensure that the resistance standard is calibrated at the required voltage. Otherwise, the voltage co-efficient must be used when determining the meter error at voltages other than the calibrated point of the standard, resulting in increased uncertainty. If the operator changes a measurement parameter such as capacitor or threshold, then the meter must be re-standardized with a reference resistor. This requirement to maintain the same capacitor and threshold settings allows for an effective Ratio for UUT:REF of 1:1, 10:1, 100:1, and in some specific cases can be extended to 1000:1. To maintain these conditions, particular care should be maintained when working with ratios which are not at 1:1 to keep the ramp time in the electrometer between 500 millisecond and 1 minute. A list of common test setups as can be found in the manual in Section 8.2 with the ramp time shown in the Table 8-4. Assuming that there is negligible environmental variation and that the test parameters are the same, then the calibrated resistance and the uncertainty of the UUT by the bridge method are characterized by the following equations (1) and (2):



$$R_{xc} = R_{sc} * R_{xm} / R_{sm} \quad (1)$$

Where:

$R_{xc}$  = Calibrated resistance value of the UUT

$R_{xm}$  = Measured resistance value of the UUT by the high resistance meter

$R_{sc}$  = Previously known calibrated resistance value of the resistance reference standard

$R_{sm}$  = Measured resistance value of the resistance standard by the high resistance meter

$$UR_{xc} = (UR_{sc}^2 + UR_{sm}^2 + UR_{xm}^2 + U_{meter}^2) \quad (2)$$

Where:

$UR_{xc}$  = Measurement uncertainty of the calibrated resistance value of the UUT

$UR_{xm}$  = Measurement uncertainty of the measured resistance value of the UUT by the high resistance meter (2 times the standard deviation)

$UR_{sc}$  = Measurement uncertainty of the previously known calibrated resistance value of the resistance standard (typically  $k = 2$ )

$UR_{sm}$  = Measurement uncertainty of the measured resistance value of the resistance standard by the high resistance meter (2 times the standard deviation)

$U_{meter}$  = Uncertainty of the 6530 in bridge mode (use the larger of bridge specifications for the two resistances measured)

### **PROCEDURE: (100 M $\Omega$ to 1 G $\Omega$ example)**

Step 1) Ensure the 6530 has been powered on and stabilized as well as the known and unknown resistor stabilized in a temperature controlled environment and sufficiently EMI shielded.

Step 2) Measure the reference resistor on the 6530. For this example the reference resistor is a 100 M $\Omega$  resistor with a traceable uncertainty of 10ppm. The measurement should run for 300 samples keeping the last 50 for determination of standard deviation and mean. The optimum measurement parameters for a 100 M $\Omega$  resistor is Test Voltage of 1 V using the 2700 pF capacitor and 10 V threshold.

Step 3) Measure the unknown resistor on the 6530. For this example, the reference resistor is a 1 GΩ resistor. Again, the measurement should run for 300 samples keeping the last 50 for determination of standard deviation and mean. The optimum measurement parameters for a 1 GΩ resistor is Test Voltage of 10 V using the 2700 pF capacitor and 10 V threshold.

Step 4) The actual value unknown resistance can then be calculated using the resistance ratio of the two measurements multiplied by the known reference resistance value. Also, the uncertainty can be calculated by combining the uncertainties of the reference resistor, the 6530 bridge specification

Using the following equations (1) and (2) defined earlier in terms of our 100 MΩ to 1 GΩ example we will use the following results:

$$\begin{aligned}
 R_{xm} &= \text{Measured UUT } 1.0000089 \text{ G}\Omega \\
 R_{sc} &= \text{Reference calibrated value } 100.0017 \text{ M}\Omega \\
 R_{sm} &= \text{Measured reference value } 100.0023 \text{ M}\Omega \\
 R_{xc} &= R_{sc} * R_{xm} / R_{sm} \\
 &= 100.0017 \text{ M}\Omega * 1.000089 \text{ G}\Omega / 100.0023 \text{ M}\Omega \\
 &= 100.0017 \text{ M}\Omega * 1.000089 \text{ G}\Omega / 100.0023 \text{ M}\Omega \\
 &= 100.0017 \text{ M}\Omega * 100.0066 \\
 &= 1.000083 \text{ G}\Omega
 \end{aligned}$$

Simplified uncertainty calculations are as follows:

$$\begin{aligned}
 UR_{xm} &= 4.756 \text{ ppm (2 times the standard deviation of UUT)} \\
 UR_{sc} &= 10 \text{ ppm reference uncertainty (typically } k = 2) \\
 UR_{sm} &= 2.013 \text{ ppm (2 times the standard deviation of UUT)} \\
 U_{\text{meter}} &= 20 \text{ ppm (larger of bridge specifications for the two resistances measured} \\
 &\quad \text{using a 6530)} \\
 UR_{xc} &= (UR_{sc}^2 + UR_{sm}^2 + UR_{xm}^2 + U_{\text{meter}}^2) \\
 &= (10^2 + 2.013^2 + 4.756^2 + 20^2) \\
 &= (10^2 + 2.013^2 + 4.756^2 + 20^2) \\
 &= (100 + 4.052 + 22.620 + 400) \\
 &= 526.672 \\
 &= 22.949 \text{ u}\square/\square
 \end{aligned}$$

As a final result in this example we have calibrated the unknown 1 G $\Omega$  resistor with respect to the known 100 M $\Omega$  resistor using the 6530 in bridge mode. This gave us the following result.

$$1.000083 \text{ G}\Omega \pm 22.949 \text{ }\mu\Omega/\Omega \text{ (ppm)}$$

The mathematics behind this process is simplified using the Transfer Cal Utility in the Guildline TeraCal Software and the process can be automated with the use of a Guildline 6564 High Resistance Scanner in conjunction with the TeraCal software.

### 3.3. CURRENT MEASUREMENT

All current sources come as a 2 terminal device. The “Output” (current out) connector of the current source should be connected to the “Input” (current in) connector of the 6530. Note that the center pin is the current path with respect to the inner shield (electrometer ground). The outer shield is primarily used for noise immunity purposes in current measurements. Refer to Figures 3-3. Many current sources also use the chassis ground as their current output reference which can be fine to short to measurement ground using the standard cable set supplied with your 6530. However, there are also cases where the current output is isolated from chassis ground. The inner shield must be used for measurement ground and **NOT** connected to the outer shield in these cases. Also note that in many cases there are active guard connectors on current sources which should **NEVER** be connected to the 6530 as damage to both devices will likely occur. Using the triax to 3-alligator connection cable found in the 6530 Lead Set Option 65225 will assist in these more complex setups.

#### 3.3.1. CURRENT MEASUREMENT PROCEDURE

To make a current measurement, do the following steps.

1. Connect the unknown current source.
2. Select the <Measure> function key in the **Main Menu**
3. Select the <Current> function key in the **Measure Option Menu**
4. Select the <Start> function key to initiate the measurement cycle.
5. The 6530 will proceed to determine the correct polarity/range and take continuous measurements.

### 3.3.2. CURRENT SOURCE CONNECTION SCHEMATIC

Outlined below is an example of a typical current source device connected to the 6530. Note that the known voltage source is not required or used and the current is actively driven from the unknown current source to the electrometer to be measured. While many current sources are referenced to chassis ground, some may not be. Use caution and refer to your current source documentation when connecting these devices. Current sources that do not use chassis ground as a reference should only be connected to the inner shield of the 6530 Input connector.

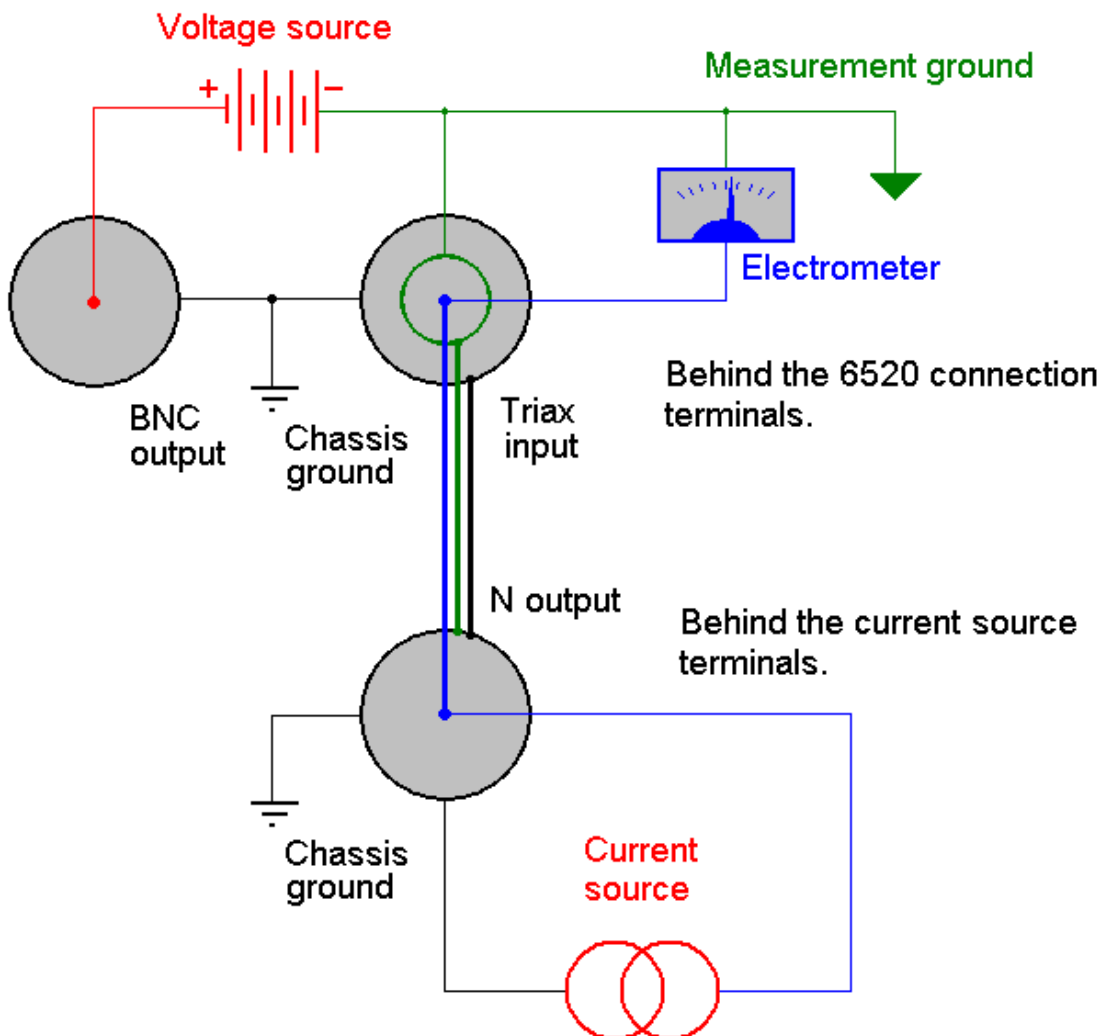


Figure 3-3: Current Source Measurement Schematic

## 4. INSTRUMENT OPERATION

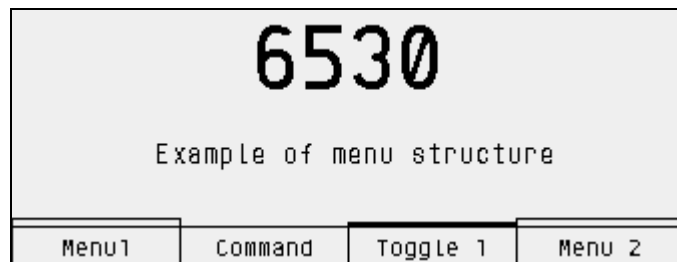
Instrument operation is controlled from a menu display and command function key approach that uses the front panel graphic display, programmable function keys, cursor movement keys and numeric keypad arrangement. The comprehensive user interface prompts the operator for the next required keystroke or it will automatically perform the required function on selection of the displayed operation.

### CAUTION

**DANGEROUS VOLTAGES CAN BE PRESENT AT THE SOURCE CONNECTOR.  
THIS EQUIPMENT MUST NOT BE OPERATED BY UNQUALIFIED PERSONNEL.**

### 4.1. BASIC MENU OPERATION

#### 4.1.1. Menu System



The basic screen structure of the 6530 has allocated the last two (2) lines of the screen to four (4) function keys. The last line contains 10 character descriptions of the function to be performed. The menu system is hierarchical, and the box of the function key has three (3) possible states.

“Menu 1” has a double box and indicates that invoking this key will select a sub-menu. “Command” indicates that this is a command key and the specified action will take place when the key is pressed.

“Toggle 1” has a double width line as a box and this indicates that this key will toggle through the defined states. In this mode the function box indicates the current state of the key.

#### 4.1.2. Key functions

Four (4) function keys are software defined within the text on the screen.

The <cancel> key cancels any data entered during an edit operation.

The <**previous**> key causes the menu system to return to the previous menu level.

Numeric keys (0-9) are used to enter data during the edit operations.

The <**clear**> key is used to clear the current entry during edit operations.

The <**exponentiation**> key is used for floating point data entry.

The <**minus**> key is used for negative numbers or as a dash in text entry.

The <**period**> key is used for floating point numbers during an edit operation.

The <**load**> key is equivalent of the enter key.

### **4.1.2.1. Navigation keys (up/down, left/right arrow)**

#### **Edit mode.**

The left arrow is used to move left to a desired location in an edit field.

The right arrow is used to move right to a desired location in an edit field.

The up arrow is used to enter the existing field and to select the previous field.

The down arrow is used to enter the existing field and to select the next field.

#### **Select mode.**

The up arrow selects the previous field.

The down arrow selects the next field.

The left arrow scrolls to the previous column of data if it exists otherwise it will select the first field.

The right arrow scrolls to the next column of data if it exists otherwise it will select the last field.

#### **View mode.**

The view portion of the 6530 uses the navigation keys to allow easy movement within the data and graph environments.

1. Summary data.

All navigation keys are not active.

2. Detail data.

The left arrow positions to the beginning of the trace buffer.

The right arrow positions to the end of the trace buffer and also activates an automatic refresh every 3 seconds.

The up arrow will scroll the data up by one entry.

The down arrow will scroll data down by one entry.

### 3. Summary graph.

All navigation keys are not active.

### 4. Detail graph.

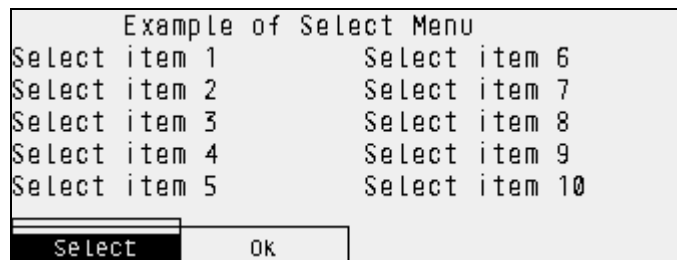
The left arrow will position the graph at the beginning of the trace buffer.

The right arrow will position the graph at the end of the buffer and activate automatic refresh as more data becomes available.

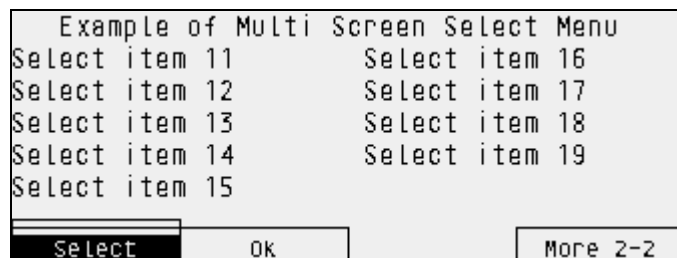
The up arrow causes the graph to scroll the graph right by the number of entries specified in the view window. (default 20)

The down arrow causes the graph to scroll left by the number of entries specified in the view window. (default 20).

#### 4.1.3. Select Mode

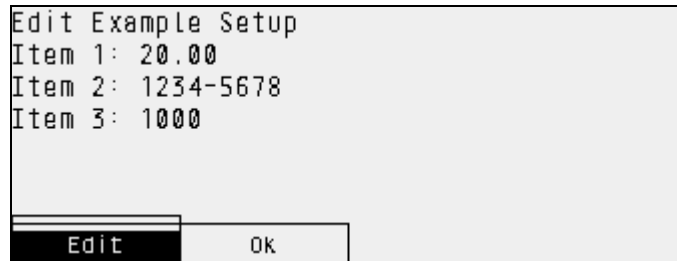


Select mode allows the selection of a specific item from a list using the navigation keys. The item is selected using the ok function key.



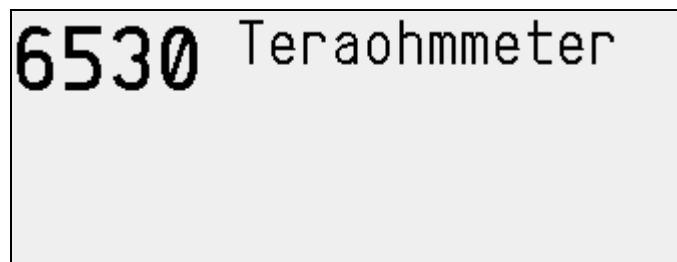
If the selections do not fit on a single screen then the fourth function key is reserved for navigating between the multiple screens.

## 4.1.4. Edit Mode



Data is entered using the numeric keys. The cancel key will restore all values to their original state. All of the data that has been changed is saved using the ok function. Multiple screens of data are processed using function key 4 (more n-n).

## 4.2. MAIN MENU



At power ON the model 6530 will start its internal power on self-test programming and display its opening banner:

When the instrument is turned on it performs a series of internal diagnostic checks. The internal diagnostics check the power supplies, reference voltage and system memory.

If the display shows the message Non-Volatile Memory Failure Press any key to continue, it indicates that the calibration data in the instrument memory has been corrupted and the operator should re-enter the proper coefficients (see SOFCAL).



<Measure> is the operations sections of the system.

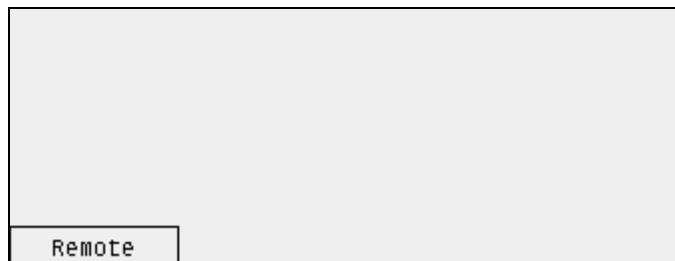


<Setup> allows the setting up of the operating environment. An example of this would be to setup the display resolution for a measurement.

<Softcal> is the calibration and diagnostics section of the system. Most of this section is under password control.

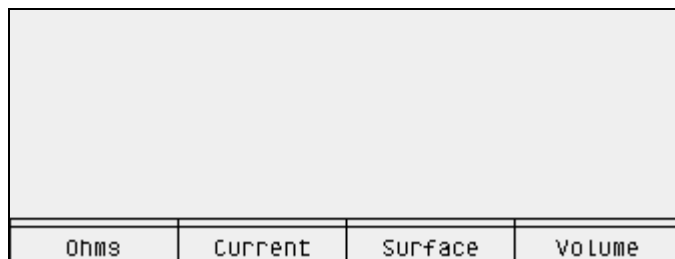
Pressing any key will remove the opening banner routines.

The REMOTE DISPLAY screen will appear only when the model 6530 has been addressed by a remote communication device on the GPIB.

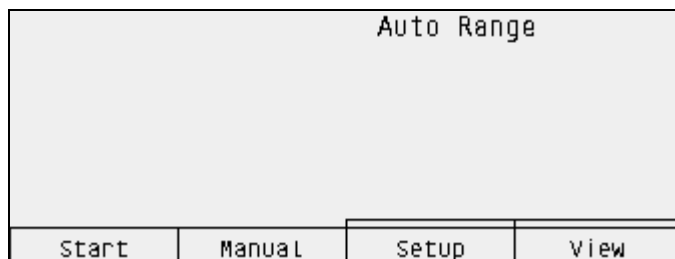


The only active soft function key that will work when in Remote mode is the function key <Remote>. The exception is when local lockout has been enabled; in this case none of the keys on the front panel will be enabled.

### 4.3. Measurement Menu

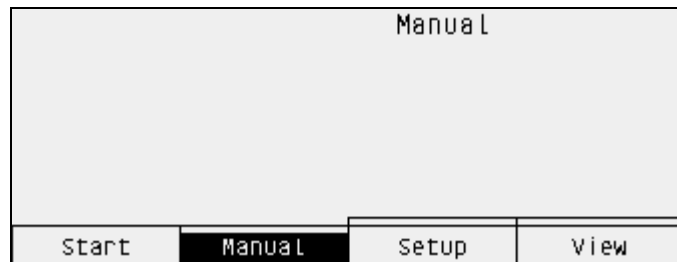


### 4.4. Ohms Measurement Menu

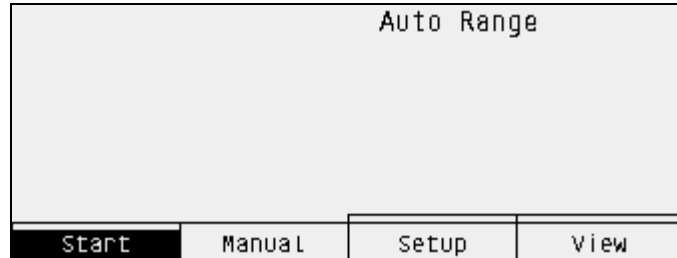


The 6530 operates in both auto range and manual mode. It is recommended that auto range mode be selected whenever possible.

As with all precision measurement instrumentation, the 6530 TeraOhm Bridge-Meter input is very sensitive to external stray electromagnetic and electrostatic fields. The presence of these stray fields can adversely affect the resistance under test as well as the 6530 reading. Proper measurement techniques for handling high impedance circuitry should be used and care should be taken to shield any device that is to be measured. Inadequate shielding will result in unstable readings. The reader should consult Section 8.7 when large value resistances are to be measured.

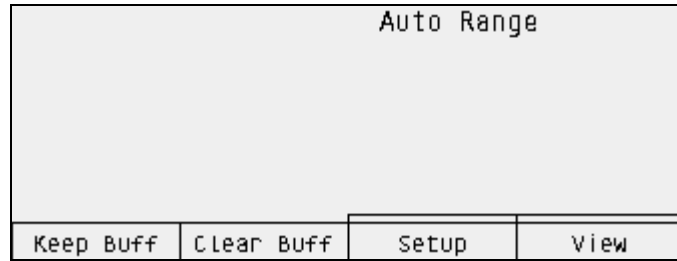


Selection of the Manual command function key puts the system in manual mode. It should be noted at this point that the 6530 will now use the current state of the parameter settings.

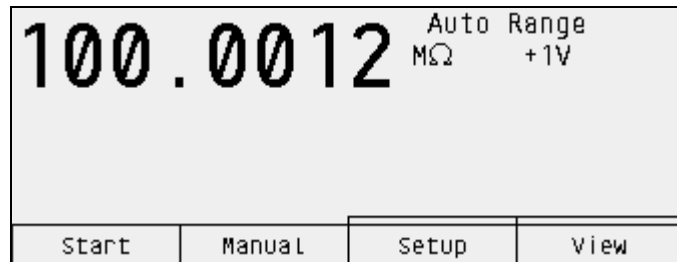


**NOTE that POTENTIALLY LETHAL VOLTAGES CAN BE PRESENT AT THE SOURCE CONNECTOR** when the measurement process is initiated. The yellow LED indicates if the voltage is present. The 6530 default maximum voltage setting is 30 volts if test voltages higher are required the maximum voltage setting must be changed in the setup menu as per section 4.4.2. For the Auto Ranging mode to function properly above 10 GΩ the maximum voltage setting should be set to 1000 volts.

If you have configured the 6530 to be in “Prompt” mode (factory default see section 4.9) then you will be greeted with the option to keep or clear the data built up from the previous measurement. If the choice is not made in 30 seconds the 6530 will default to keeping the previous data.



The 6530 will check the value of the resistor and select the optimum parameters for measurement purposes. It will report the approximate setting that it is trying to use as it locates the best settings.

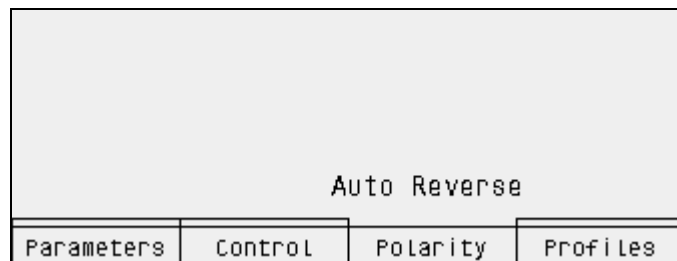


The 6530 will display the measurement values as they become available. It will also display the voltage that is being supplied to the output terminal. This example illustrates +1 volts.

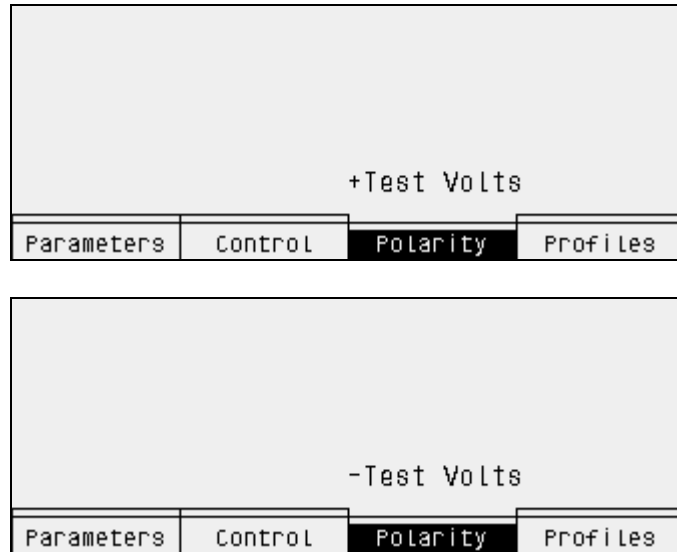
### 4.4.1. Ohms Setup



If some of the current settings need to be viewed or changed, selection of the Setup sub-menu is required.



The setup menu allows the user to select the polarity using the polarity command function.



Changing polarity will not stop the measurement. It is recommended that attention is paid to the parameters for auto reverse as this will drastically affect the accuracy of the measurement. Voltage reversals for measurements greater than 10 G $\Omega$  require longer settling time. If the system is configured in 6530 mode and autoranging is used then the system will automatically select appropriate parameters for sample size and sample count based on the resistance. (see section 4.9.2.2.5 System parameter) In manual mode Auto Reverse Sample Count and Stabilize Size (4.4.6. Timers) are used to establish these values.

## 4.4.2. Ohms Parameters Menu

Auto Reverse			
Parameters	Control	Polarity	Profiles
Manual			
90k - 200M OHMS			
2700pF	10.0V	1V	30V
Capacitor	Threshold	Test Volts	Max Volts

The parameters menu allows the manual selection of settings.

The Max Volts limits all measurements. Max Volts is set to 30 V as power up default. This also applies to auto ranging. This may be important to note as some resistors may be damaged if high voltage is applied. The valid ranges are:

1 V    10 V    100 V    1000V  
3 V    30 V    300 V

Selection of the Capacitor, Threshold or Test Volts command will automatically set the measurement mode to manual and stop the measurement if it is active.

The Test Volts command selects the voltage to be used during the measurement. The valid ranges are the same as Max Volts however it will not allow the selection to exceed Max Volts. The Max Volts will have to be increased if the desired voltage is greater than Max Volts. This is a deliberate limit to ensure that the voltage is not accidentally changed above the tolerance of the resistor. In Auto Range mode the 6530 will not provide a calibrated measurement if Max Volts is set too low.

The capacitor command selects the integrating capacitor. The valid capacitor values are:

27 pf    270 pf    2700 pf

The 27 pf and 270 pf selections are only available if the 0.1 V threshold is selected.

The Threshold command selects the threshold voltage. The valid voltages are:

0.1 V    1.0 V    10.0 V

The 6530 will display the suggested range of the resistor based on the selected settings. This suggestion can be ignored but it may have a direct effect on the accuracy of the measurement and/or the length of time for a measurement to take place. In Auto Range mode the parameters are automatically selected up to the Max Volts setting.

### **4.4.3. RESISTANCE, MANUAL RANGING**

Manual ranging of the 6530 TeraOhm Bridge-Meter is more complex than using the autoranging function. To fully understand the manual mode, Section 1.1.2 (Principle of Operation) should be reviewed.

The manual mode permits the operator to select the test voltage, the threshold voltage and the integration capacitor. The operator may also select these constants through the GPIB or RS-232C remote communication link. The instrument then measures the integration time and calculates the value of the unknown resistance. If the operator selects inappropriate measurement constants, the full accuracy of the instrument may not be achieved. To make a good selection, an approximate value of the unknown resistor is required. This may be obtained from a prior knowledge or from a repetitive sequence of measurements starting from any assumed value. The instrument works best if the integration time is between 0.54 and 54.0 seconds, however it will work at reduced accuracy with an integration time as short as 5.4 milliseconds or as long as 1000 seconds. The integration capacitor value may be selected from one of 27, 270 or 2700 picofarads. The 2700 pF capacitor is the most stable and should be used if possible.

The threshold may be 0.1 V, 1 V or 10 V. The test voltage may be selected between the limits of (1 to 1000) V in steps that are decimal multiples of 1 and 3 of either polarity ( $\pm$ ).

The integration time is affected by the selection of the capacitor, threshold and test voltage according to the formula:

$$T = \frac{2 \times C \times R \times V_{\text{threshold}}}{V_{\text{source}}}$$

Where: T is the integration time in seconds,

R is the unknown resistance in ohms,

C is the integrator capacitance in farads,

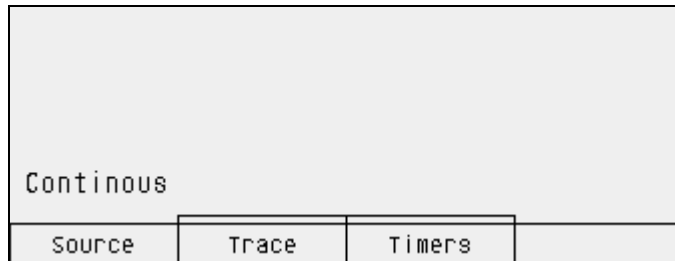
$V_{\text{threshold}}$  is the threshold voltage in volts,

$V_{\text{source}}$  is the test voltage in volts.

The operator may use the timing diagram of Table 8-5 to select the measurement constants without calculation. For example, if the unknown resistor value is approximately 100 M $\Omega$ , the operator will find the sloping 100 M $\Omega$  line on the test voltage graph (top of the page). The intersection of the 100 M $\Omega$  line with the horizontal 10 V test voltage line gives an input current of 100 nA (vertical line). Following the 100 nA line to the 2700 pF threshold voltage graph (center of page) it can be seen that selecting a 10 V threshold will give an integration time of 540 milli-seconds (ms) which is within the optimum range of 0.54 to 54.0 seconds. The selection of the 0.1 V threshold should be avoided because it would give an integration time of 5.4 ms.

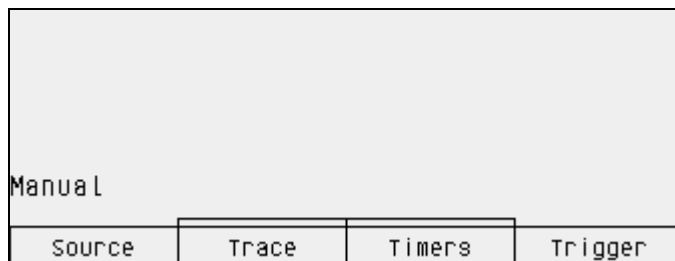
Another thing that should be considered is the voltage used within the measurement. If the measurement is being performed at low voltages (100 V or less) then the integration time is best to be within 5.4 to 54 seconds. This longer integration time will improve the stability of the inherently lower signal to noise ratio with lower voltages.

## 4.4.4. Control Menu



The valid Source selections are:

**Manual** - requires trigger from <**Trigger**> function key to start a measurement. <**Trigger**> is also available on the Ohms Measurement Menu if this mode is selected



**External** - external trigger contact closure required on external trigger source on input connector

**BUS** - measurement initiated by \*TRG remote command

**Continuous** - continuous measurement



## 4.4.5. Trace

Timestamp Temperature Humidity Atmospheric Pressure Machine State  RT Clock			
ALL	None	Time Mode	More 1-3

<All> selects Timestamp, Temperature, Humidity, Atmospheric Pressure, and Machine State.

<None> clears all trace elements.

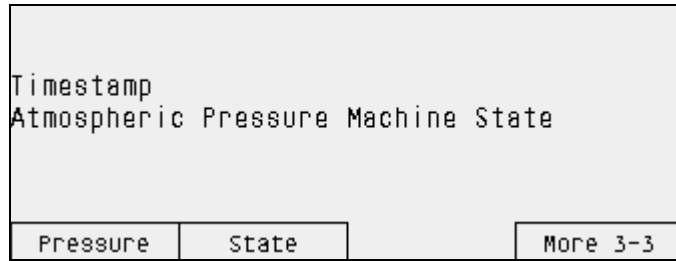
<Time Mode> toggles between Relative Time and the Real Time Clock. This is only traced if Timestamp is selected.

Timestamp Atmospheric Pressure Machine State			
Time Stamp	Temp.	Humidity	More 2-3

<Time Stamp> selects and removes the Time Stamp in the trace.

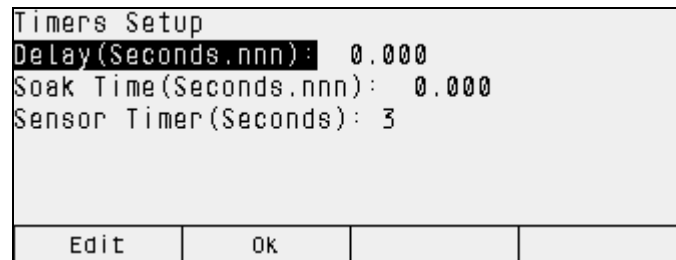
<Temp.> selects and removes the Temperature data in the trace.

<Humidity> selects and removes the Humidity data in the trace.



<Pressure> selects and removes the atmospheric pressure data from the trace.  
 <State> selects and removes the machine state data from the trace.

### 4.4.6. Timers

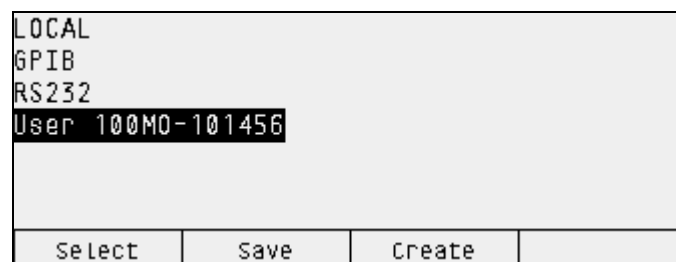


Delay is the time to wait between each sample. It is an internal time based sample trigger.

Soak Time is the initial settling wait time after a change in voltage or polarity.

Sensor Time is the wait time between sensor measurements.

### 4.4.7. Profiles



Profiles allow the user to select standard default setups or to create individual user profiles. 36 profiles are available in the 6530; 3 are fixed (LOCAL, GPIB, RS232) and 33 are user definable. The remaining 33 profiles are stored in non-volatile memory and will be retained by the 6530 even after powering off.

<Select> allows the selection and deletion of profiles.



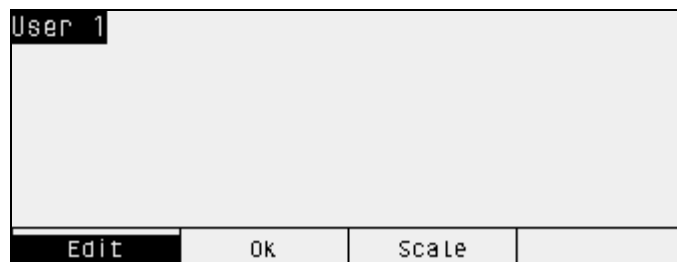
<Ok> selects the highlighted profile.

<Delete> deletes the currently selected profile. This option is only available on user profiles and will not be present when LOCAL, GPIB, or RS232 is highlighted.

<Save> saves the current profile information in the selected profile.

The saved parameters are: Delay Time, Soak Time, Sensor Time, Trigger Source, Display Resolution, Display Brightness, Auto Reverse Mode, Manual Mode, GPIB status, RS232 status, Capacitor, Threshold, Polarity, Max Voltage, Output Test Voltage.

<Create> allows the creation of a new profile using the current profile information.



<Ok> creates a new profile with the name as entered in the text. The current profile information will be saved in this profile.

<Scale> allows the insertion of special text for defining the resistor value. It toggles between M Ohms, G Ohms, T Ohms and P Ohms.

## 4.4.8. View

The **View Menu** allows the user to view the trace data in graphical and text format. The last 1000 entries are kept in memory and the individual entries can be viewed. A summarization of the data is kept from the last **<Clear Sum>** point. A graphical summary is also maintained by averaging all samples within a 180 point array.

Auto Range			
Summary	Graph	Detail	Window

### 4.4.8.1. Summary

MΩ	Detail	Summary	
Minimum -	99.9979486	99.9979486	
Maximum -	99.9989347	99.9992902	Count
Average -	99.9983568	99.9985756	1
Std Dev -	2.96660102	3.88303008	(PPM)
Samples -	24	38	
Refresh	Confirm	Cancel	Detail

The **Count** entry indicates how many actual values have been averaged within the summary graph.

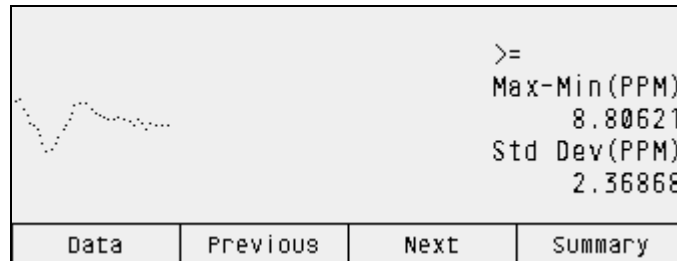
**<Refresh>** updates the detail and summary values.

**<Detail>** switches to the Detail display.

**<Clear Det>** clears the trace buffer. It requires a confirmation to prevent accidental clearing.

**<Clear Sum>** clears the summary buffer

## 4.4.8.2.Detail Graph



<Data> switches to the detail display.

<Previous> (if present) scrolls the trace buffer window left.

<Next> (if present) scrolls the trace buffer window right.

<Summary> switches to the summary display.

The Up arrow scrolls the trace buffer left by Up/Down Arrow Scroll Size.

The Down arrow scrolls the trace buffer right by Up/Down Arrow Scroll Size.

The Left Arrow scrolls to the beginning of the trace buffer.

The Right Arrow scrolls the end of the buffer and sets the trace in automatic update mode. The >= symbol in the display indicates that the auto update mode is enabled.

### 4.4.8.3.Detail

=> MΩ	Time	C	%RH	Kpa	ct	volts
99.9980954	17:14:51.26	23	40	85	22	+5
99.9981951	17:14:51.26	23	40	85	22	+5
99.9982376	17:14:51.26	23	40	85	22	+5
99.9981986	17:14:51.26	23	40	85	22	+5
99.9982593	17:14:51.26	23	40	85	22	+5

Graph	Previous		Summary
-------	----------	--	---------

<Graph> switches to the graph display.

<Previous> (if present) scrolls back by 5 entries.

<Next> (if present) scrolls forward by 5 entries.

The Up arrow scrolls the trace buffer up by one (1) entry.

The Down arrow scrolls the trace buffer down by one (1) entry.

The Left Arrow scrolls to the beginning of the trace buffer.

The Right Arrow scrolls the end of the buffer and sets the trace in automatic update mode.

The ct value is interpreted as follows:

c-t	Capacitor (pf)	Threshold (V)
0	27	0.1
1	270	1
2	2700	10

### 4.4.8.4.Window

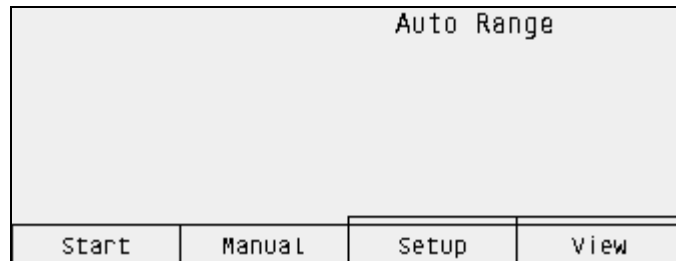
View Detail Graph Setup	
Detail Graph Window Size: 180	
Up/Down Arrow Scroll Size: 20	
Refresh Minimum Scroll Size: 20	
Edit	OK

Detail Graph Window Size is the number of trace entries to display on the graph.

Up/Down Arrow Scroll Size is the number of trace entries to scroll by during Up/Down arrow selection in the detail graph.

Refresh Minimum Scroll Size is the number of entries to leave available for update when the detail graph which is currently being viewed reaches the Detail Graph Window Size. This prevents the screen from doing a complete refresh on each new entry once the window size is less than the number of trace entries.

## 4.5. Current - MEASURING PICOAMPERES



With the Current Option the 6530 TeraOhm Bridge-Meter can be used to measure very low Direct Currents flowing to the center conductor of the input connector. The 6530 input resistance is approximately 100 kΩ when measuring currents to 10 μA and reduces to approximately 100 Ω (by enabling the internal current shunt) for currents to 10 mA and will reduce the expected current flow if the voltage compliance of the current source is not high enough. To connect the unit as a pico-ammeter, the current source is fed into the center conductor of the INPUT connector. The INPUT connector inner shield is the current return path to the ground (or low side) of the external circuit. The connector outer shield is connected to the cable shield and safety ground of the 6530.

A coaxial cable to the INPUT connector makes a simple approximation to the ideal circuit configuration when the center conductor is connected to the current source and the coaxial shield is connected to the ground of the external circuit. Noise pickup may cause a slight degradation of accuracy when using this coaxial cable configuration. Guildline supplies a triaxial cable where the outer and inner shield are joined together at the Type-N connector end.

## 4.5.1. AUTORANGING - Current

The simplest technique for measuring low currents is to use the autoranging feature of the 6530:

1. Connect the unknown current source.
2. Select the **<Measure>** function key in the **Main Menu**
3. Select the **<Current>** function key in the **Measure Option Menu**
4. Select the **<Start>** function key to initiate the measurement cycle.
5. The 6530 will proceed to determine the correct range and take continuous measurements.
6. The autoranging feature of the 6530 will track slow changes in the magnitude of the unknown current, but if the current changes by a large step value, or if the polarity

changes, the instrument must be forced to autorange again by pressing the **<Stop>** function key to terminate the measurement and then the **<Start>** function key to initiate the measurement cycle.

7. Select the **<Set Up>** function key in the **Measure Option Menu**
8. Change the polarity of the expected measurement process by selecting the appropriate polarity from the available options **<Polarity +>**, **<Polarity ->**.
9. Press the front panel menu control key **<PREVIOUS>** to return menu control to the **Measure Option Menu**.
10. Select the **<Start>** function key to initiate the measurement cycle.

## 4.5.2. MANUAL RANGING - Current

Manual ranging of the 6530 TeraOhm Bridge-Meter is more complex than the autoranging function. Reference to the Time Diagram shown in Figure 4-1 and Table 8-5 are useful when operating the 6530, especially in the manual ranging mode. In order to manual range an approximate value of the current to be measured must be known.

Knowing the current the user must then select an integration capacitor, an integration threshold voltage, and the shunt for the measurement. The integration capacitor value may be selected from one of 27 pF, 270 pF or 2700 pF. The threshold may be 0.1 V, 1 V or 10 V. The shunt can be on or off.

The selection of the capacitor, the threshold, and the shunt affects the integration time according to the formula:

$$T = \frac{2 \times C \times V_{\text{threshold}} \times \text{Shunt}}{I}$$

Where: T is the integration time in seconds,



I is the unknown current in amperes,

C is the integration capacitance in farads,

$V_{\text{threshold}}$  is the threshold voltage in volts.

Shunt is 1000 if it has been selected otherwise it is 1. Note: The shunt should be enabled only when trying to measure currents higher than 10  $\mu\text{A}$ .

The instrument works best if the integration time of the electrometer is between 0.5 s and 5 s however integration times as short as 5.4 ms or as long as 1000 s may be used. The 2700 pF capacitor is the most stable and should always be used if possible.

The following steps can be used to measure current in the manual mode:

1. Connect the unknown current source.
2. Select the **<Measure>** function key in the **Main Menu**
3. Select the **<Current>** function key in the **Measure Option Menu**
4. Select the **<Set Up>** function key in the Measure Option Menu to proceed to the Set Up Menu
5. Select **<Parameters>** in the Set Up Menu to proceed to the Parameters menu
6. Using the suggested timing parameters suggested by entries into the Time Diagram of Figure 4-1 and Table 8-5 to make the appropriate selection of **<Capacitor>**, **<Threshold>** and **<Shunt>**.
7. Press the front panel menu control key **<PREVIOUS>** to return menu control to the Set Up menu.
8. Select the expected test current polarity using the **<Polarity>** function key; (the polarity convention used is such that for a positive polarity, the centre conductor of the INPUT connector is at a positive voltage with respect to the inner shield.)
9. Press the front panel menu control key **<PREVIOUS>** to return menu control to the **Measure Option Menu**.
10. Select the **<Start>** function key to initiate the measurement cycle.

Auto range		
100u - 10m Amps		
2700pf	10.0V	Off
Capacitor	Threshold	Shunt Res.

Capacitor 27 pF | 270 pF | 2700 pF  
 Threshold 0.1 V | 1.0 V | 10.0 V  
 Shunt On | Off

#### 4.6. Surface Resistivity

Select <Measure> function key in the **Main Menu**

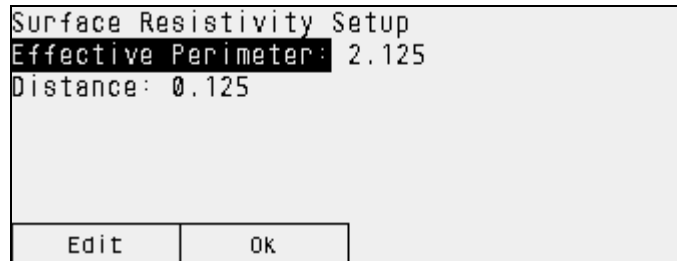
Select <Surface> function key in the Measure Option Menu

Auto Range	
Surface Resistivity	
Continue	Configure

Auto Range			
Surface Resistivity			
Start	Manual	Setup	View

<Continue> will set the system in Surface Resistivity mode and start the Ohms Menu (4.4).

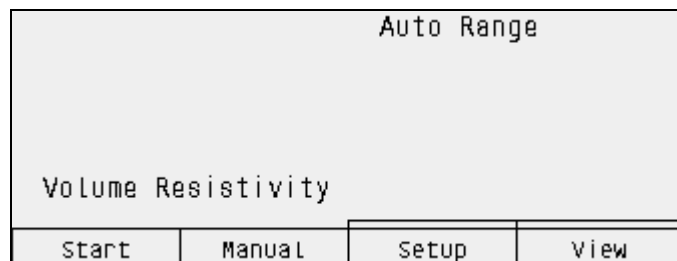
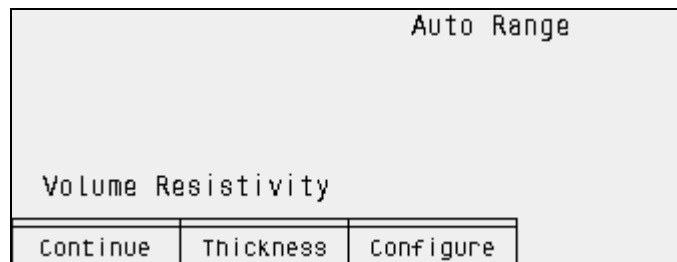
## 4.6.1. Surface Resistivity Configure



The effective perimeter and distance are fixed parameters for the Model 8009 Resistivity Test Fixture. For a detailed description of these parameters consult the Keithley Model 8009 manual. This is only used for custom fixtures and is not part of the menu selection when the fixture is standard. (see configure).

## 4.7. Volume Resistivity

Select <Measure> function key in the **Main Menu**  
 Select <Volume> function key in the Measure Option Menu



<Continue> will set the system in Volume Resistivity mode and start the Ohms Menu (4.4)

## 4.7.1. Volume Resistivity Thickness Setup

Auto Range			
Volume Resistivity			
Start	Manual	Setup	View

The thickness of the sample can be changed from the default if necessary. For a detailed description of these parameters consult the Keithley Model 8009 manual.

Units allows the selection of inches or centimeters. The configuration values are automatically converted.

## 4.7.2. Volume Resistivity Configure

Volume Resistivity Setup	
Diameter:	2.125
Distance:	0.125
Area Coefficient:	0.000
Edit	OK

The effective diameter and distance are fixed parameters for the Model 8009 Resistivity Test Fixture. For a detailed description of these parameters consult the Keithley Model 8009 manual. This is only available when a custom fixture is selected from the Configure menu.

## 4.8. Configure

Select <Configure> function key in the **Main Menu**

Auto Range			
Analog			
6530	Disp Res 6	Ramp	More 1-4

<6530> sets System Mode to Native 6530 Operation <Trace 6530> sets System Mode to trace raw data.

Resolution for displaying the measurement. 3 | 4 | 5 | 6 | 7 | 8 | Auto Res.

<Ramp> The “Ramp” is the voltage output level of the integrating circuit of the electrometer. It is a good status indicator to show the circuit operation. Setting the “Ramp” to Digital displays ramp volts in digital and Analog displays the ramp graphically.

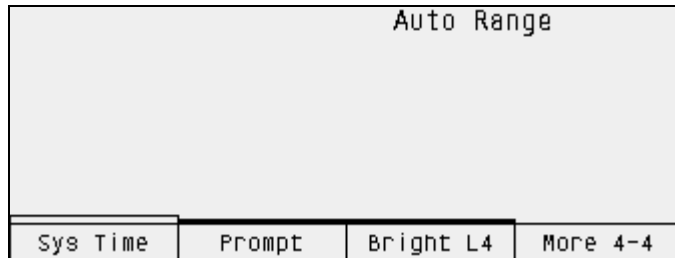
Auto Range			
Gpib	RS232	Sensors	More 2-4

Auto Range			
Standard			
Off			
Fixture	Inches	Interlock	More 3-4

<Fixture> allows the selection of the Standard Guildline Resistivity fixture and also allows the user to define a custom fixture.

<Inches> toggles between inches and centimeters.

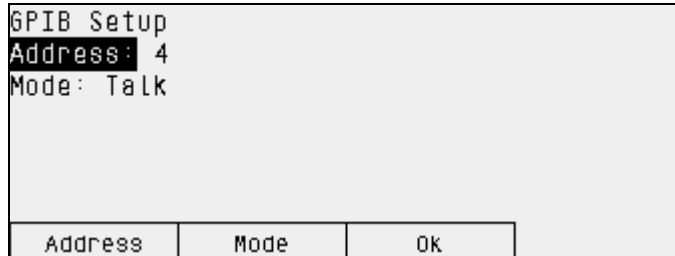
<Interlock> can be off or on. On prevents an Ohms measurement if the external input is not enabled. Resistivity always operates in interlock “on” mode. (This switch is for Manual operation only; see Service Manual SM6530 for Remote operation.)



<Prompt> selects the buffer clear mode. The “Prompt” selection will prompt you before each new measurement to either clear or keep the last measurement in the buffer. The “Keep Data” and “Clear Data” options will always act the labelled manner without prompting.

Bright sets the display brightness. L1 | L2 | L3 | L4.

### 4.8.1. GPIB



Address is the GPIB device address 0-30. The standard device is 4.

Mode Talk | Talk/Listen | Disabled

Ok is necessary to save the parameters and initialize the device.

## 4.8.2. RS232

RS232 Setup			
Baud: 9600	Flow Control: XON/XOF		
Parity: NONE	Mode: Talk Only		
Stop Bits: 1			
Data Bits: 8			
Echo: ON			
Baud	Parity	Stop Bits	More 1-3

Baud is the RS232 Baud Rate. 1200 | 4800 | 9600 | 19200 | 38400 | 115200.  
 Parity NONE | EVEN | ODD  
 Stop Bits 1 | 2

RS232 Setup			
Baud: 9600	Flow Control: XON/XOF		
Parity: NONE	Mode: Talk Only		
Stop Bits: 1			
Data Bits: 8			
Echo: ON			
Data Bits	Echo	Flow Ctrl	More 2-3

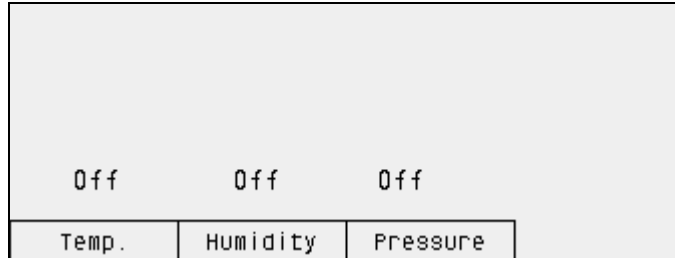
Data Bits 7 | 8  
 Echo ON | OFF  
 Flow Control XON/XOFF | RTS/CTS | NONE

RS232 Setup			
Baud: 9600	Flow Control: XON/XOF		
Parity: NONE	Mode: Talk Only		
Stop Bits: 1			
Data Bits: 8			
Echo: ON			
Mode	OK		More 3-3

Mode Talk Only | Talk Listen | Disable

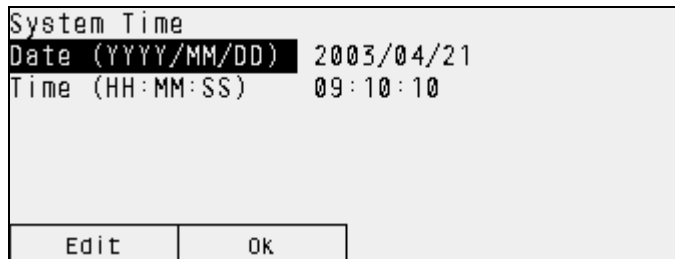
<Ok> is necessary to save the parameters and initialize the device.

### 4.8.3. Sensors



This enables/disables the three (3) sensors. The off state will stop all monitoring of the selected sensor.

### 4.8.4. Sys Time



This allows the updating of the system date and time. The time is entered in 24 hour format.

## 4.9. Sofcal



Section 6 provides a detailed explanation of calibration with the Sofcal program.



## 4.9.1. User



### 4.9.1.1. Calibration Coefficients

This menu displays the Calibration coefficients. It can be updated to re-enter the coefficients from the report given with you 6530 in the event of a non-volatile memory failure. These values are determined during the factory alignment or calibration.

Calibration Coefficients			
-1 V	0	-300 V	465
-3 V	495	-1000 V	355
-10 V	497	+1 V	465
-30 V	435	+3 V	495
-100 V	435	+10 V	497
			Scrn 1-2

Calibration Coefficients			
+30 V	0	270pF	2495
+100 V	495	2700pF	3380
+300 V	497	Prot.	100030
+1000 V	435	0.1V	348
27pF	95543	1.0V	105
			Scrn 2-2

### 4.9.1.2. Self Test

```
Self Test - (Rev A Date 2012/01/20)
Error Status : 0 0 0-00000000 0-0000
ROM Checksum : 24891
AUX ROM Checksums : -14501,25332
NVSRAM Checksum : -18246
OK          Press any key to exit
```

Self Test checks various parameters and displays the results.

Error Status. Bit 0 – Non-Volatile checksum failure

Bit 1 – Rom checksum failure. Could be ROM/Aux ROM.

Bit 2 – Analog failure.

Bit 3 - +5 volts

Bit 4 - -5 volts

Bit 5 - +15 volts

Bit 6 - -15 volts

Bit 7 – Precharge

Bit 8 – High voltage monitor

Bit 9 – 10 volt reference

Bit 10 - Ramp

Bit 11 – Digital failure.

Bit 12 - +5 volts

Bit 13 - -5 volts

Bit 14 - +15 volts

Bit 15 - -15 volts

## 4.9.2. Calibrate

Sofcal Calibrate Menu  6530 Teraohmmeter Rev A 2012/01/20			
Utilities	Cal. Vals	Ref. Vals	Sensors

<Utilities> is used to calibrate the capacitors, thresholds, protection resistor and shunt.

<Cal. Vals> is used to enter or modify the test volts, threshold, protection resistor and shunt correction values.

<Ref. Vals> is used to enter/modify the instrument serial number, calibration date, auto cal parameters, zero parameters and shunt parameters.

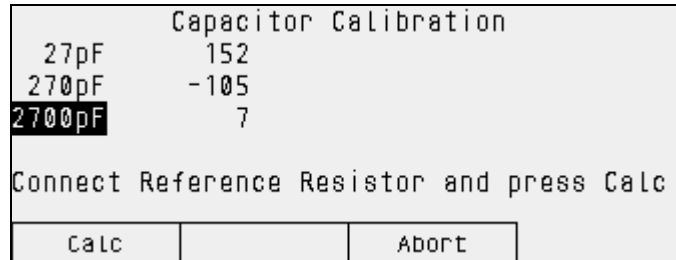
### 4.9.2.1. Utilities

It should be noted that the instrument may not reach a stable state if it is running in a environment which has climate fluctuations or high levels of electrical or other interference. In some cases it may be necessary to change the variance or the standard deviation from the system default values as displayed in the “Ref-Vals” submenu. If any of the calibration routines is unable to meet the specification then an error message <\*\*\* Sample Maximum Exceeded> will be displayed and the procedure will be aborted.

Utilities Menu  6530 Teraohmmeter Rev A 2012/01/20			
Auto Cal.	Cap Cal.	Thresh Cal	More 1-2

Utilities Menu  6530 Teraohmmeter Rev A 2012/01/20	
Zero Cal.	More 2-2

## 4.9.2.1.1.Auto Calibration



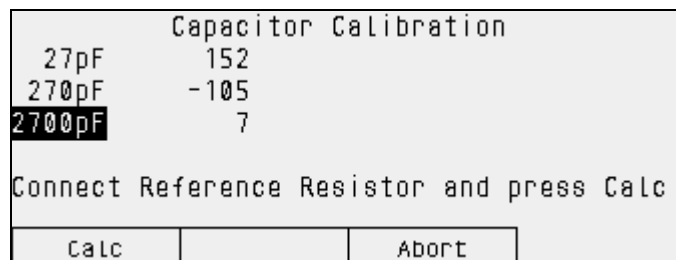
This automates the Capacitor and Threshold calibrations. It utilizes the same procedures as the Capacitor and Threshold calibration, but it automatically steps through the three capacitors and the two thresholds. It also automatically sets the calibration date from the system date/time.

<Calc> starts the automated procedure.

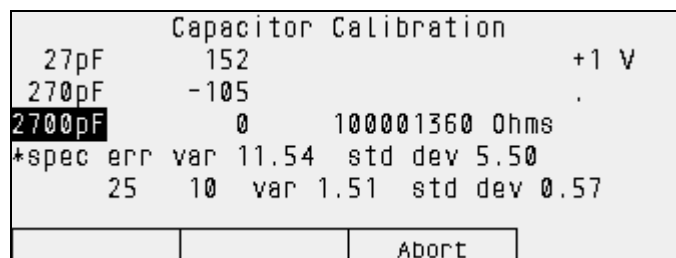
<Abort> stops the procedure and restores the values to their original state.

## 4.9.2.1.2.Cap Calibration

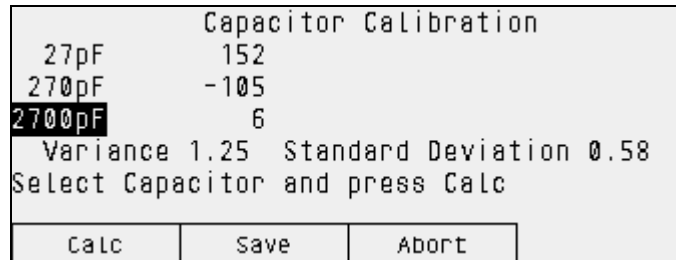
The calibration coefficient is the difference in parts per million (ppm) between the measured value and the current value of the three integrating capacitors used in the 6530. The three coefficient values are stored in the instrument's memory and are used to compensate resistance measurements. If the capacitor values should ever change or if the value in memory should become corrupted, the SOFCAL program is able to measure the true value and store the new Capacitor coefficient value in the 6530 memory in place of the old stored value.



Select the desired capacitor with the Up/Down Arrow and press <Calc>.



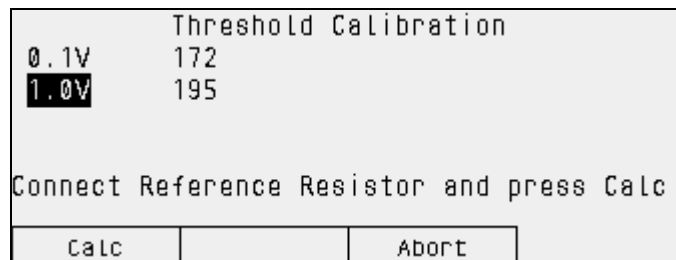
If the specified variance or standard deviation is exceeded, then the sample count is reset to zero and the failed spec is displayed on the 5<sup>th</sup> line of the display. Line 6 of the display consists of the total measurement count, the number of samples which have currently been taken for the valid sample set and the current variance (in ppm) and standard deviation (in ppm) for the valid sample set.



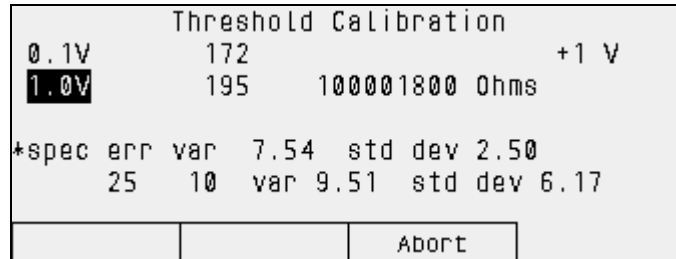
When the number of samples specified has been measured and have not exceeded the specification then the calibration routine has successfully completed and the actual variance (ppm) and standard deviation (ppm) is displayed. If for some reason the routine continues until the maximum retries has been reached, then the last window of samples is used to generate the actual variance (ppm) and standard deviation (ppm) that is displayed. The values are not stored in the 6530 non-volatile memory. When the calibration is complete it will allow the user to <save> the values or to select another capacitor and <Calc> the calibration coefficient.

### 4.9.2.1.3. Threshold Calibration

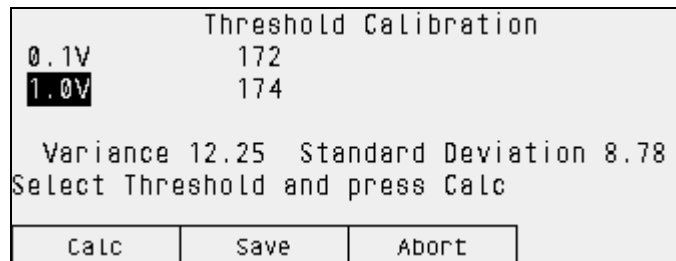
This is the difference in ppm between the measured value and the actual value of the threshold voltages occurring at the integrator output. The threshold coefficient values for the 0.1 V and 1 V thresholds are stored by the 6530 and are used to correct the unknown resistance and current measurements.



Select the desired threshold with the Up/Down Arrow and press <Calc>.



If the specified variance or standard deviation is exceeded, then the sample count is reset to zero and the failed spec is displayed on the 5<sup>th</sup> line of the display. Line 6 of the display consists of the total measurement count, the number of samples which have currently been taken for the valid sample set and the current variance (ppm) and standard deviation (ppm) for the valid sample set.

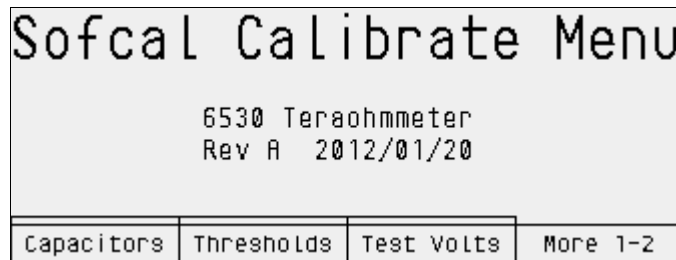


When the number of samples specified has been measured and have not exceeded the specification then the calibration routine has successfully completed and the actual variance (ppm) and standard deviation (ppm) is displayed. If for some reason the routine continues until the maximum retries has been reached, then the last window of samples is used to generate the current variance (ppm) and standard deviation (ppm) that is displayed. The values are not stored in the 6530 non-volatile memory. When the calibration is complete it will allow the user to <save> the values or to select another capacitor and <Calc> the calibration coefficient.



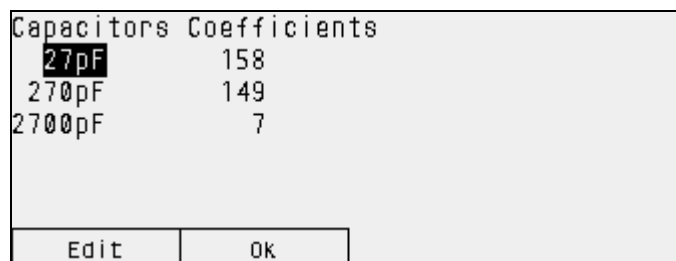
actual variance (ppm) and standard deviation (ppm) is displayed. If for some reason the routine continues until the maximum retries has been reached, then the last window of samples is used to generate the actual variance (ppm) and standard deviation (ppm) that is displayed. The values are not stored in the 6530 non-volatile memory. When the calibration is complete it will allow the user to <save> the values or to select another capacitor and <Calc> the calibration coefficient.

### 4.9.2.2. Calibration Coefficient Values



This section allows the editing of the calibration coefficients values.

#### 4.9.2.2.1. Capacitor Coefficients



Pressing the <Capacitors> key will display the coefficients stored for each capacitor. By pressing the <Edit> key the numbers may be altered by pressing a new sequence of numbers followed by pressing the <Ok> key. Pressing the <PREVIOUS> key exits to the SOFCAL Calibrate Menu.

#### 4.9.2.2.2. Threshold Coefficients



Threshold Coefficients	
0	174
1.0V	113

Edit	OK
------	----

Pressing the <Thresholds> key will display the coefficients stored for each threshold. By pressing the <Edit> key the numbers may be altered by pressing a new sequence of numbers followed by pressing the <Ok> key. Pressing the <PREVIOUS> key exits to the SOFCAL Calibrate Menu.

### 4.9.2.2.3. Test Volts

Voltage Coefficients			
-1 V	0	-300 V	465
-3 V	495	-1000 V	355
-10 V	497	+1 V	465
-30 V	435	+3 V	495
-100 V	435	+10 V	497

Edit	OK		Scrn 1-2
------	----	--	----------

Voltage Coefficients	
+30 V	0
+100 V	495
+300 V	497
+1000 V	435

Edit	OK		Scrn 2-2
------	----	--	----------

Pressing the <Test Volts> key will display the test voltages and the coefficients stored for each step. A new value may be entered for each test voltage by pressing the <Edit> key and the numeric keys for the new value, followed by the <Ok> key. Press the UP or DN key to select the next test voltage coefficient. The different test voltages are: (1; 3; 10; 30; 100; 300; 1000) V in both polarities (±). To determine the output test voltage coefficient a DC Voltmeter must be connected to the Output/Source connector. The following equation is used to calculate the value to enter for each output test voltage range. (see section 6.1.2)

$$\text{Test Voltage} = \frac{\text{number to be keyed} \times \text{DC V reading} - |\text{Nominal Voltage}|}{10^6}$$

Coefficient into display | Nominal Voltage |

Due to the large number of output test voltage points to be measured during calibration, it is recommended that the numbers are entered using one of the interface busses (GPIB or RS-232C).

#### 4.9.2.2.4. Cal Spec.

	Count	Sample	Variance	Std Dev
27pF	260	100	1.673	0.574
270pF	95	60	6.565	1.749
2700pF	96	30	1.023	0.545
0.1V	173	100	5.645	1.482
1.0V	90	60	1.825	0.632

Press any key to exit

This displays the statistics of the last time that the Utilities were used to establish the Capacitor and Threshold coefficients. It displays the total count of samples required to meet the specification as well as the actual variance and standard deviation for the specified sample size.

#### 4.9.2.2.5. System Parameters

System Parameters			
Sample Count	90	2700pF	10.0V
Sample Size	100		
Window Size	1		
Positive Coefficient	-734		
Negative Coefficient	-734		
Edit	OK	90k-200k	1V

Pressing the <Sys Params> key will display the system parameters stored for the 6530. <Function key 3> selects the resistance range. <Function key 4> selects the available voltage within the resistance range. By pressing the <Edit> key the numbers may be altered by pressing a new sequence of numbers followed by pressing the <Ok> key. Pressing the <PREVIOUS> key exits to the SOFCAL Calibrate Menu.

NOTE: Do not alter the system parameters as they will affect the accuracy of the 6530. These are factory set parameters. Access to the parameters is only recommended in the event of a non-volatile memory failure, to confirm and, if required, edit them to return them to the values set by the factory. These values are supplied in hard copy on the instrument report.

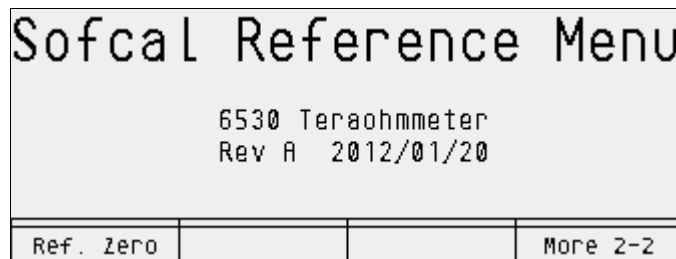
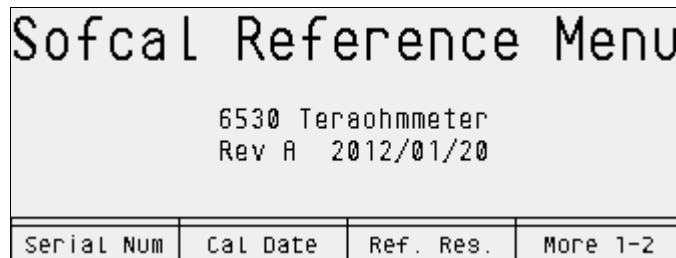
## 4.9.2.2.6. Protection Resistor



Pressing the <Protection> key will display the error stored for the internal series protection resistor. By pressing the <Edit> key the number may be altered by

pressing a new sequence of numbers followed by pressing the <Ok> key. Pressing the <PREVIOUS> key exits to the SOFCAL Calibrate Menu

## 4.9.2.3. Reference Values



### 4.9.2.3.1. Serial Number

6530 Serial Number			
Serial Number 67526			
Edit	Ok		

Used to record serial number from the back plate of 6530.

### 4.9.2.3.2. Calibration Date

Calibration Date/Time	
Date (YYYY/MM/DD)	2003/04/21
Time (HH:MM:SS)	11:25:01
Edit	Ok

This is the date of the last calibration. If a new calibration date is to be entered press the **<Edit>** key. A new date may be keyed in with the numeric keys of the keypad. The calibration date is saved when the **<Ok>** key is pressed. Pressing the **<PREVIOUS>** key exits to the SOFCAL Calibrate Menu.

This is used to record the last date of calibration. It needs to be updated when the 6530 is re-calibrated.

### 4.9.2.3.3. Reference Resistor

Reference Resistor Calibration Values			
Reference Resistor	100001200		
Serial Number	123456		
Variance 2700pF (PPM)	5.00		
Standard Dev. 2700pF	2.5		
Sample Size 2700pF	30		
Edit	OK		Scrn 1-4

Reference Resistor Calibration Values			
Variance 270pF (PPM)	7.00		
Standard Dev. 270pF	3.50		
Sample Size 270pF	60		
Variance 27pF (PPM)	10.00		
Standard Dev. 27pF	5.00		
Edit	OK		Scrn 2-4

Reference Resistor Calibration Values			
Sample Size 27pF	100		
Variance 1.0V (PPM)	3.00		
Standard Dev. 1.0V	1.25		
Sample Size 1.0V	60		
Variance 0.1V (PPM)	12.00		
Edit	OK		Scrn 3-4

Reference Resistor Calibration Values			
Standard Dev. 0.1V	3.5		
Sample Size 0.1V	100		
Maximum Sample Count	3000		
Edit	OK		Scrn 4-4

This is used to record the value of the reference resistor used to calibrate the 6530. It is critical that it be entered prior to calibration of the 6530.

A separate value for variance, standard deviation and sample size is used for 2700 pF, 270 pF, 27 pF, 1.0 V threshold and 0.1 V threshold.

Variance is the difference between the maximum and minimum reading in ppm. This is used to ensure that the reading has stabilized before calculating the calibration coefficient.

Standard deviation (ppm) is used to further ensure that the measurement is stable and within spec.

Sample Size is used to specify the number of measurements to be used for calculating the coefficients.

Maximum Sample Count is set to specify the total number of measurements to be taken before the process is interrupted. Maximum Sample Count is a global setting for all tests in the Auto Cal functions.

It should be noted that the instrument may not reach a stable state if it is running in an environment which has climate fluctuations or high levels of electrical or other types of interference. This will result in the 6530 running until the Maximum Sample Count is reached for each test that cannot satisfy the criteria set in Standard Deviation and Variance. In some cases it may be best to change the variance or the standard deviation from the system default values.

**System Default Values:**

	Variance	Standard Deviation	Sample Size
<b>2700 pF</b>	5.00 (ppm)	2.50 (ppm)	30
<b>270 pF</b>	7.00 (ppm)	3.50 (ppm)	60
<b>27 pF</b>	10.00 (ppm)	5.00 (ppm)	100
<b>1.0 V</b>	3.00 (ppm)	1.25 (ppm)	60
<b>0.1 V</b>	12.00 (ppm)	5.00 (ppm)	100

**Maximum Sample Count**                    3000 (global setting for each test)

**4.9.2.3.4. Protection Resistor Reference Values**

Protection Resistor Calibration Values					
Variance (PPM)	200.00				
Standard Deviation	100.00				
Sample Size	25				
Maximum Sample Count	1000				
<table border="1" style="width: 100%; border-collapse: collapse;"> <tr> <td style="width: 25%; text-align: center;">Edit</td> <td style="width: 25%; text-align: center;">OK</td> <td style="width: 25%;"></td> <td style="width: 25%;"></td> </tr> </table>		Edit	OK		
Edit	OK				

Variance is the difference between the maximum and minimum reading in ppm. This is used to ensure that the reading has stabilized before calculating the calibration coefficient.

Standard deviation (ppm) is used to further ensure that the measurement is stable and within spec.

Sample Size is used to specify the number of measurements to be used for calculating the coefficients.

Maximum Sample Count is set to specify the total number of measurements to be taken before the process is interrupted.

It should be noted that the instrument may not reach a stable state if it is running in an environment which has climate fluctuations or high levels of electrical or other types of interference. This will result in the 6530 running until the Maximum Sample Count is reached for each test that cannot satisfy the criteria set in Standard Deviation and Variance. In some cases it may be best to change the variance or the standard deviation from the system default values.

**System Default Values:**

Variance	Standard Deviation	Sample Size
200.00 (ppm)	100.00 (ppm)	30

**Maximum Sample Count** 1000

**4.9.2.4.Sensors**



This section allows setting the gain and Offset Voltage for the sensors. The gain is specified in mV per each unit of measurement.

**N.B. The default parameters are set for the Guildline environmental sensors option.**

### 4.9.2.4.1. Temperature

Temperature Coefficients	
Gain (mv/°C)	83.333
Offset Voltage	0.4170
Edit	OK

This example supports a sensor that generates 417 mV at 0 °C and has a sensitivity of 83.333 mV/°C.

### 4.9.2.4.2. Humidity

Humidity Coefficients	
Gain (mv/%RH)	50.000
Offset Voltage	0.000
Edit	OK

This example supports a sensor that generates 0 V at 0 % rH and has a sensitivity of 50 mV/% rH.

### 4.9.2.4.3. Pressure

Pressure Coefficients	
Gain (mv/kPa)	105.000
Offset Voltage	-6.390
Edit	OK

This example supports a sensor that generates -6.390 V at 0 kPa atmospheric pressure and has a sensitivity of: 105 mV/kPa.



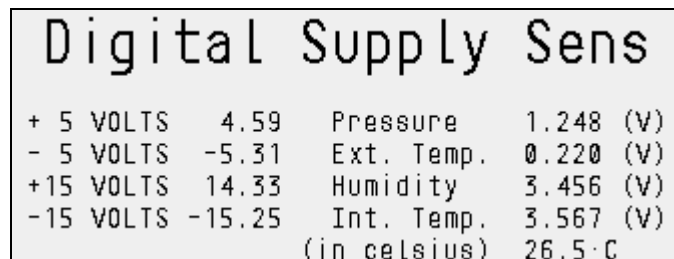
### 4.9.3. Diagnostics



<ErrMsg Off> | <ErrMsg On> Disables/Enables on screen error messages.

The diagnostics section is used by the service technician to monitor voltage and to allow the testing of some of the input and outputs of the system.

#### 4.9.3.1. Digital PS



The screen updates the values every 5 seconds.  
Any key exits to the Diagnostics Menu.

### 4.9.3.2. Analog PS

Analog Power Supply			
+ 5 VOLTS	4.59	- 5 VOLTS	-4.98
+15 VOLTS	15.02	-15 VOLTS	-15.06
PRECHARGE	-9.95	HV MON	-0.57
10V REF	10.01	RAMP	-12.11

The screen updates the values every 5 seconds.  
Any key exits to the Diagnostics Menu.

### 4.9.3.3. Relay Test

U800/J801 Test 1			
U704/J700	U800/J801	250 ms	

This diagnostic tool requires a Guildline test jig and is only used by a qualified Guildline technician. It allows the monitoring of the digital outputs of the CPU board through the LED indicators on the test jig. An example of this is the source voltage relay controls (J801-9 – J801-15).

User selectable time delay between setting relays. 250 ms | 500 ms | 1 s | 2 s

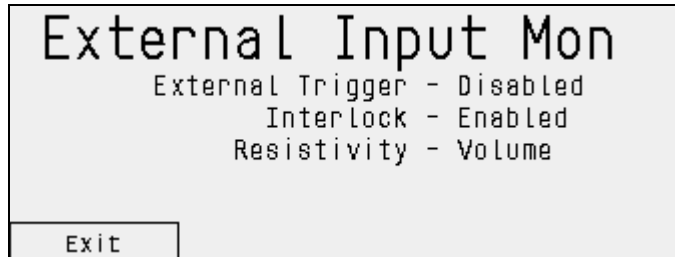
### 4.9.3.4. Voltage Test

Output Voltage Source Test	
1V	100V
3V	300V
10V	1000V
30V	
Positive	
Volts On	Polarity

This procedure requires the use of a DC Voltmeter.

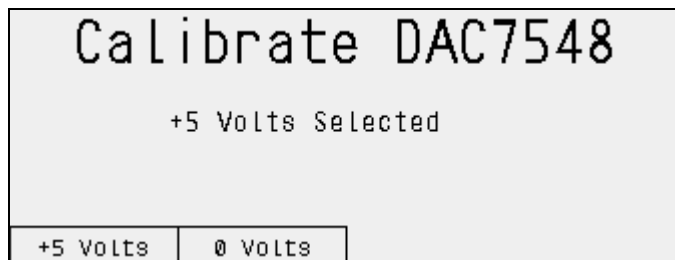
Volts On/Volts Off turns the high voltage on/off.  
Polarity Positive | Negative

### 4.9.3.5.External Input



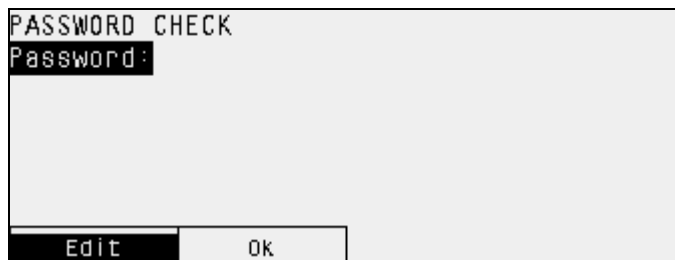
This is used to check the status of external inputs. It can also be used to test the inputs. Interlock can be disabled from the Configure Menu.

### 4.9.3.6.DAC7548 Calibrate



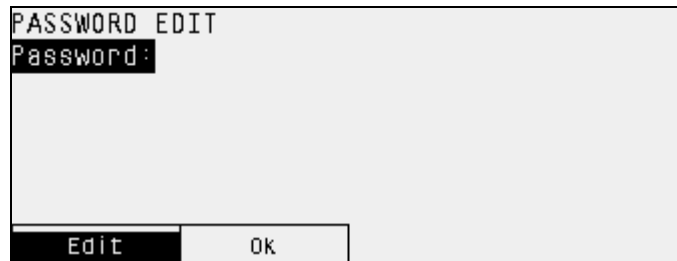
This is a factory calibration procedure for aligning the DAC7548 and is not part of the operational procedures.

### 4.9.4. Password



This is to allow the updating of the password. The system default password is 6530.

Enter the current password then press <Ok>.



If the system is signed on with the correct password, then the system will prompt for the new password.

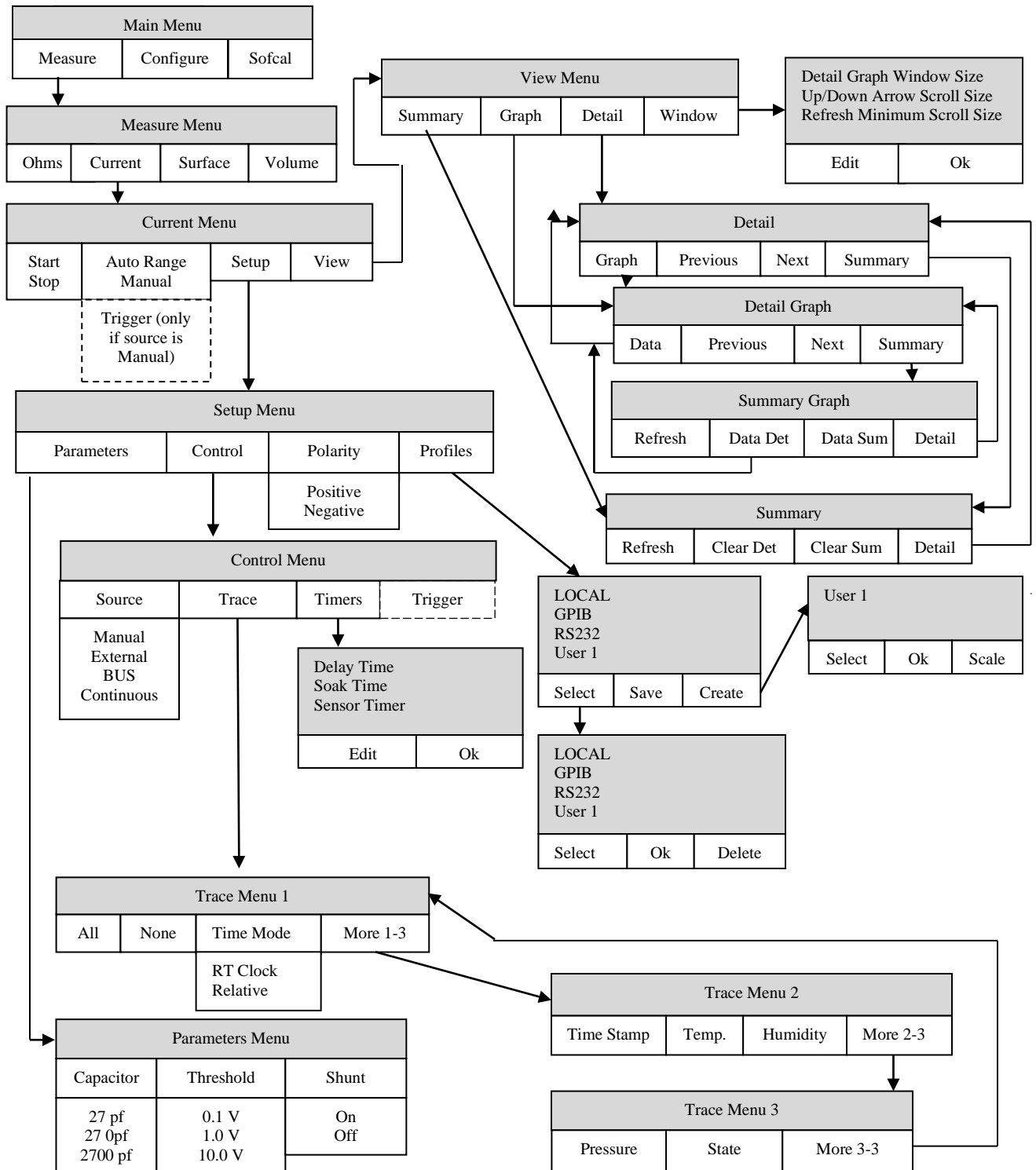
Enter the new password then press **<Ok>**.

**<PREVIOUS>** will return to the **Sofcal Menu**.

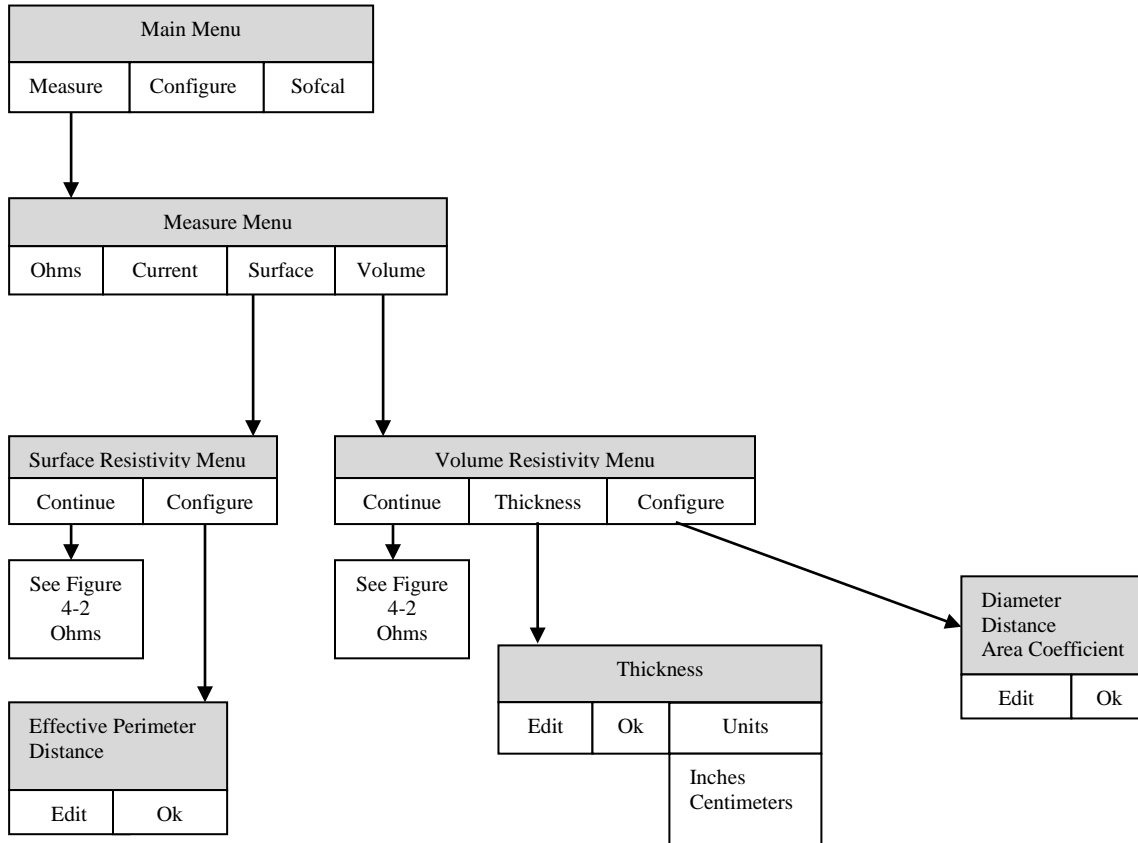
#### 4.10. Menu System Hierarchy Diagrams

The menu system hierarchy used by the 6530 is outlined below. It has a separate section for Ohms, Current, Resistivity, Setup, and Calibrate.

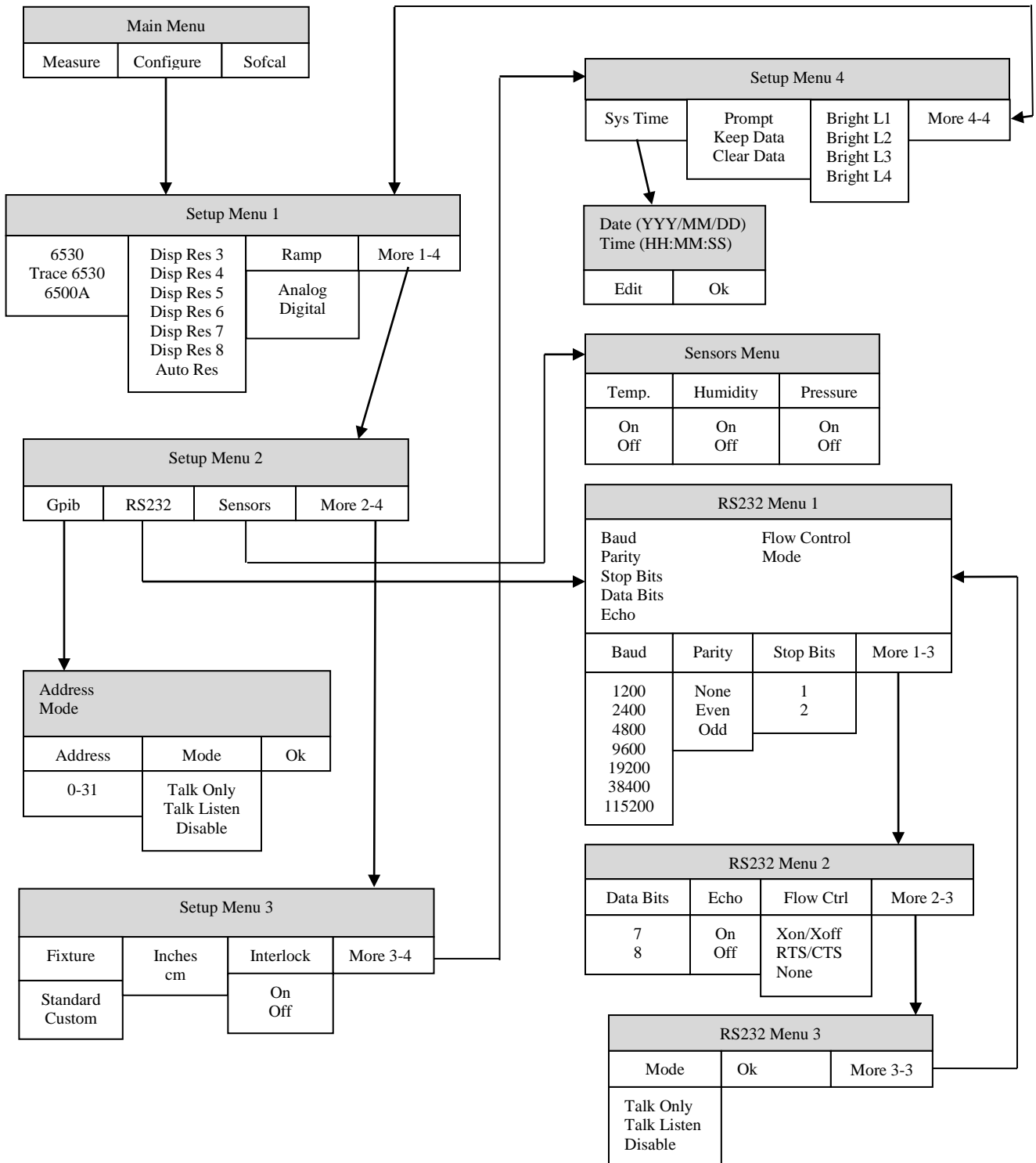




**Figure 4-2: Current Hierarchy**

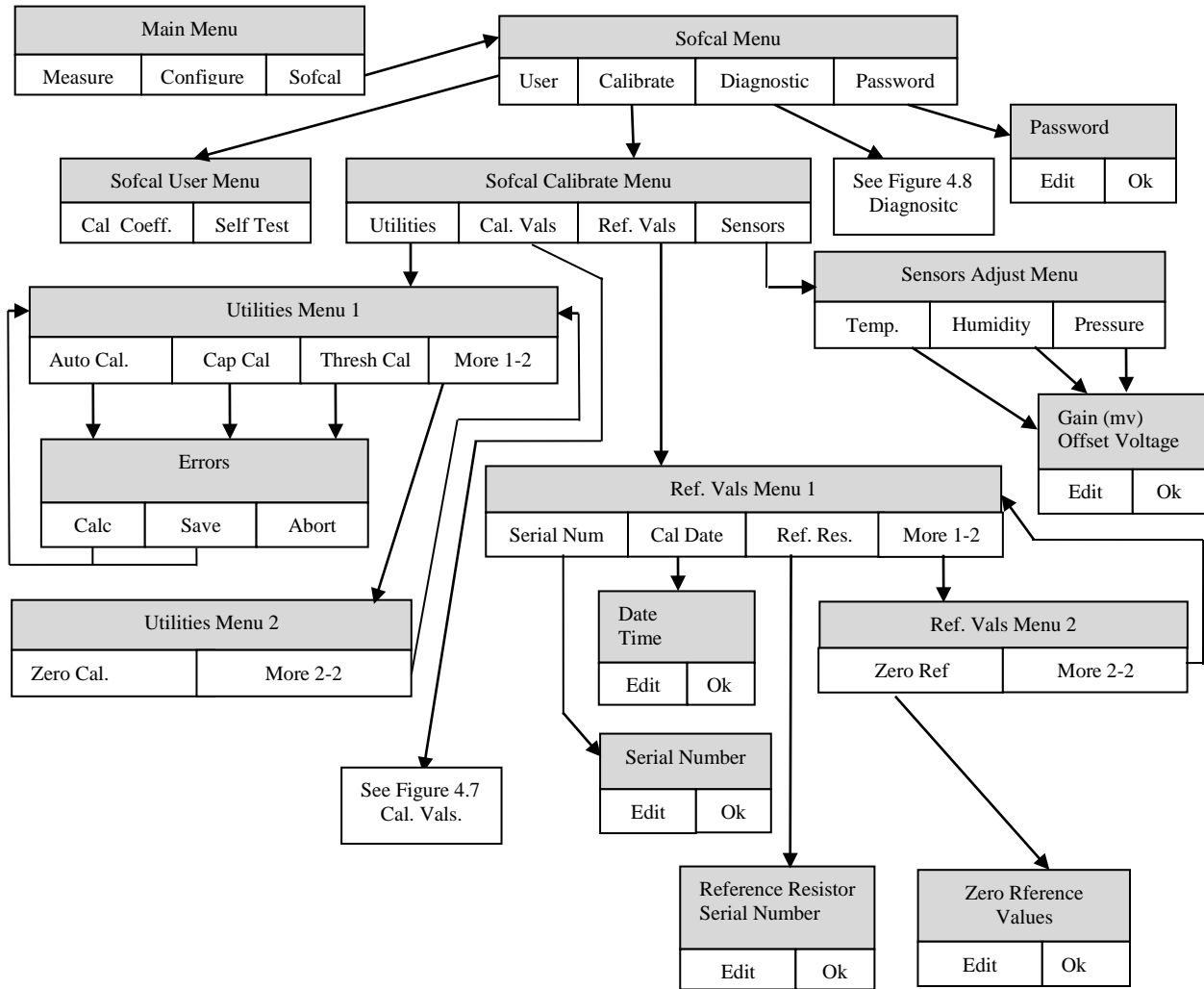


**Figure 4-3: Resistivity Hierarchy**

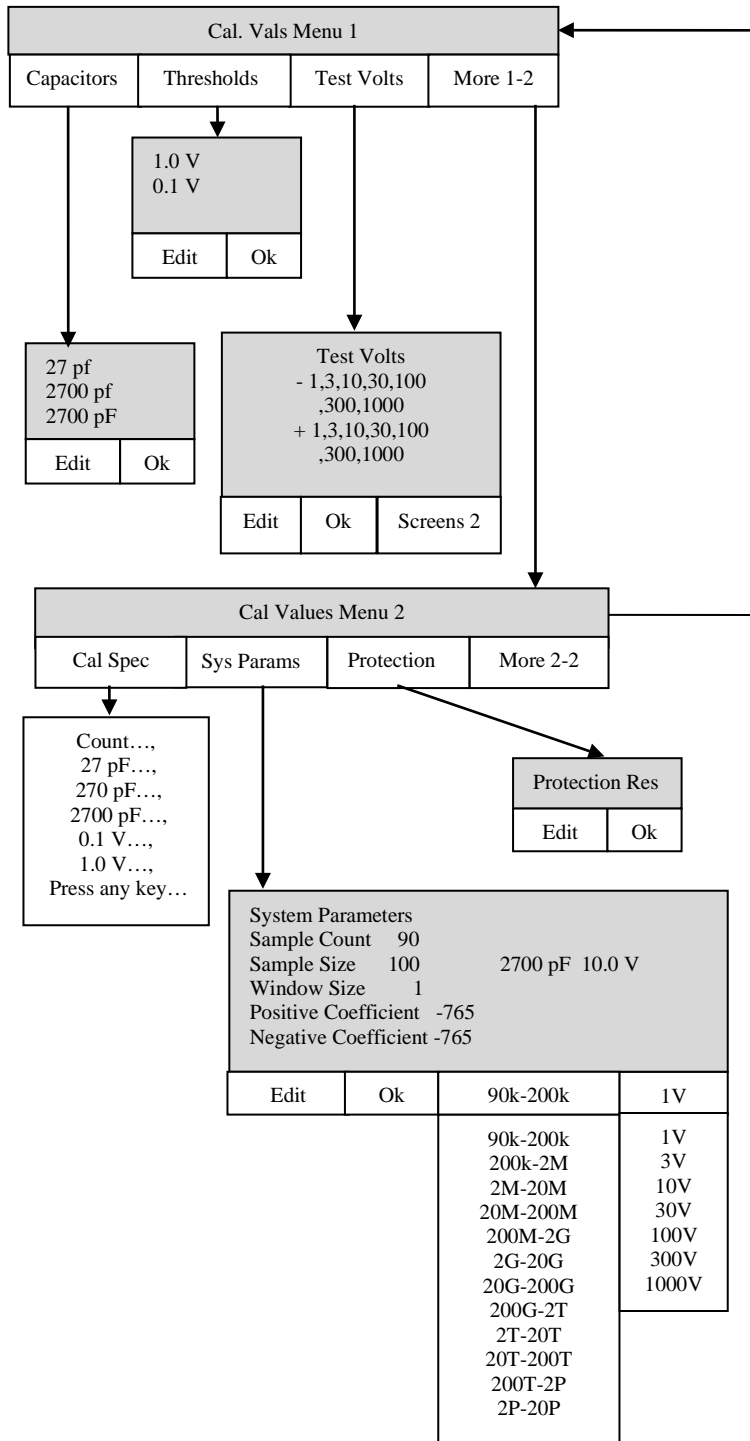


**Figure 4-4: Setup Hierarchy**

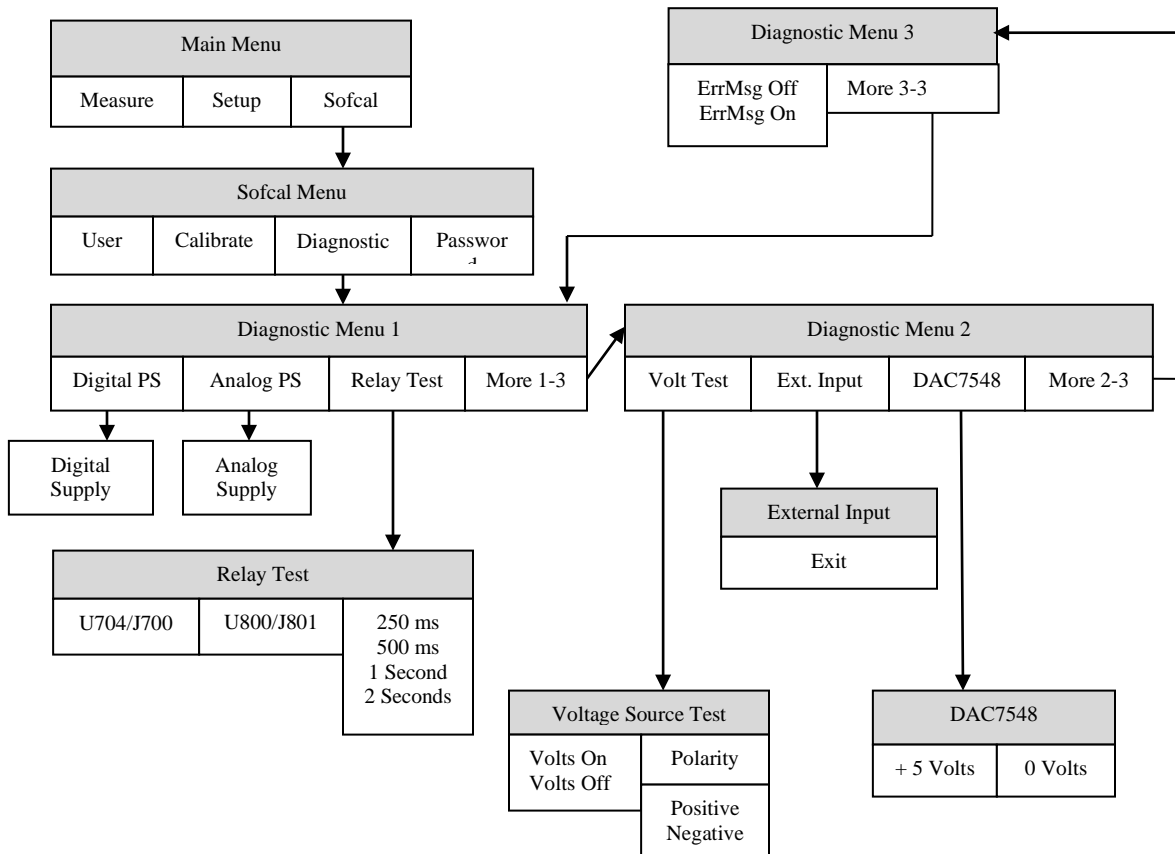




**Figure 4-5: Sofcal Hierarchy**



**Figure 4-6: Sofcal Cal. Vals. Hierarchy**



**Figure 4-7: Sofcal Diagnostic Hierarchy**



## 5. REMOTE CONTROL

The 6530 TeraOhm Bridge-Meter operates directly from the front panel or under remote control of an instrument controller, computer or terminal. Remote control can be interactive, with the user controlling each step from a terminal, or under the control of a computer running the 6530 in an automated system. It is also possible to connect a printer to the remote interface of the 6530 and have the 6530 output some or all of the measurements taken to the printer for a permanent record.

This chapter describes the interfaces and the commands to which the 6530 will respond. The setting of the IEEE-488 address and mode is described in OM6530 Section 5.8.1.

### 5.1. INTERFACES

The model 6530 has two interfacing standards available:

- A parallel interface conforming to IEEE-488.2.
- A serial interface conforming to RS-232C.

The IEEE-488 connector is mounted to the rear panel. The IEEE-488 address defaults to a factory setting of 04. This setting can be viewed and set to a valid address using the front panel controls.

The RS-232C connector is mounted on the rear panel but it has to be configured from the front panel.

The 6530 can be operated in a system where both RS-232C and IEEE-488 interfaces are being used. It can be controlled with an IEEE-488 bus and a printer connected to the RS-232C output for permanent records of measurements.

In a system containing more than one controller, only one controller can exercise control while the other stays in dormant state until control is transferred.

### 5.2. IEEE-488 (GPIB) INTERFACE

The 6530 is fully programmable for use on the IEEE standard 488.1 interface bus (also known as the General Purpose Interface Bus (GPIB)). The interface is also designed in compliance with the supplemental standard IEEE-488.2. Devices connected to the bus in a system are designated as talkers, listeners, talker/listeners, or controllers. The 6530 can be operated on the IEEE-488 bus as a talker or under the control of an instrument controller as a talker/listener.

This manual assumes that the user is familiar with the basics of the IEEE-488 interface bus. The IEEE-488 interfacing standard applies to the interface of instrumentation systems or portions of them, in which the:

1. Data exchanged among the interconnected apparatus is digital.
2. Number of devices that may be interconnected by one contiguous bus does not exceed 15.
3. Total transmission path length over interconnecting cables does not exceed the lesser of either 20 meters or 2 meters times the number of devices on the bus.
4. Data rate across the interface on any signal line does not exceed 1 megabit per second.

### **5.2.1. CONTROLLER**

There can be only one designated controller in charge on the IEEE-488 bus. This device exercises overall bus control and is capable of both receiving and sending data. The rest of the devices can be designated as listener, talker or talker/listener.

The controller can address other devices and command them to listen, address one device to talk and wait till the data is sent. The controller sets data routes but it need not take part in the data interchange.

All controller query and command sequences should be terminated with the line-feed character (0x0A) and/or optionally; the controller should assert the EOI data byte control signal.

### **5.2.2. IEEE-488 RESPONSES**

The reply to any IEEE-488 query command will be a sequence of ASCII characters followed by a line-feed character (0x0A). The line-feed character may also be expressed as  $0A_{16}$  or  $10_{10}$  or  $12_8$  or Ctrl-J. Throughout this manual we will use the "C" programming language notation for expressing numbers in base 16, specifically 0x0A indicates that 0A is to be interpreted in base 16 (hex).

### **5.2.3. INTERCONNECTING CABLE AND IEEE-488 CONNECTOR**

The interconnecting cable of IEEE-488 1978 consists of 24 conductors, 16 conductors are for carrying signals and 8 for grounding. An individual cable assembly may be up to 4 meters long and should have both a plug and a receptacle connector type at each end of the cable. Each connector assembly is fitted with a pair of captive locking screws.

### **5.2.4. TYPICAL SYSTEM**

**Data Input/Output Lines** - The 8 data I/O lines form the data bus over which data between the various devices is transmitted under the supervision of the controller. The message bytes are carried on Data I/O signal lines in a bit parallel byte serial form, asynchronously and generally in a bi-directional manner.

**Handshake or Data Byte Control** - the three interface signals are used to effect the transfer of each byte of data on the DIO signal lines from a talker or controller or one or more listeners.

1. DAV (DATA VALID) is used to indicate the condition of (availability and validity) information on the DIO signal lines.
2. NDAC (NOT DATA ACCEPTED)
3. NRFD (NOT READY FOR DATA) is used to indicate the condition of readiness of devices to accept data.
4. SRQ (SERVICE REQUEST) is used by a device to indicate the need for attention and to request an interruption of the current sequence of events.
5. REN (REMOTE ENABLE) is used (by a controller) in conjunction with other messages to select between two alternate sources of device programming data.
6. EOI (END OR IDENTIFY) is used (by a talker) to indicate the end of a multiple byte transfer sequence or in conjunction with ATN (by a controller) to execute a polling sequence.
7. ATN (ATTENTION)
8. IFC (INTERFACE CLEAR)

### 5.2.5. ADDRESS AND TALK/LISTEN SELECTION

The IEEE-488 Address and Talk/Listen status can be set using the front panel controls as directed by the operator menu system. If there is no controller and the 6530 is hooked up to a printer for hard copy then Talk Only mode should be selected as the preferred mode of operation.

### 5.2.6. IEEE-488 ELECTRICAL INTERFACE

The 6530 meets the subsets of the IEEE-488 interface specification IEEE-488.1 shown in Table 5-1. The pin connections on the IEEE-488 interface connector are shown in Table 5-2.

Pin Connection	Name	Function
Source Handshake	SH1	complete source handshake capabilities.
Acceptor Handshake	AH1	complete acceptor handshake capabilities.
Talker	T5	has a talker capability with a single primary address in the range 0 to 30. Extended addressing is not implemented. Talk only.
Listener	L4	supports basic listener with unaddressed if MTA(My Talk Address) is received. The talk and listen addresses will always be the same. Does not support extended listen addresses. Does not support Listen Only.
Service Request	SR1	complete service request generation capabilities.
Remote Local	RL1	all functions on the front panel can be locked out by the IEEE-488 controller.
Parallel Poll	PP0	no parallel poll capabilities.
Device Clear	DC1	full device clear capabilities.
Device Trigger	DT0	no device trigger capabilities.
Controller	C0	can never become the bus controller.
Electrical Interface	E2	all required electrical interface capability.

**Table 5-1 : IEEE-488 Device Capabilities**

Pin	Name	Description
1	DIO1	Data Input Output Line 1
2	DIO2	Data Input Output Line 2
3	DIO3	Data Input Output Line 3
4	DIO4	Data Input Output Line 4
5	EIO	End or Identify
6	DAV	Data Valid
7	NRFD	Not Ready for Data
8	NDAC	Not Data Accepted
9	IFC	Interface Clear
10	SRQ	Service Request
11	ATN	Attention
12	SHIELD	Screening on Cable (connected to safety ground)
13	DIO5	Data Input Output Line 5
14	DI06	Data Input Output Line 6
15	DIO7	Data Input Output Line 7
16	DIO8	Data Input Output Line 8
17	REN	Remote Enable
18	GND6	Ground wire of twisted pair with DAV
19	GND7	Ground wire of twisted pair with NRFD
20	GND8	Ground wire of twisted pair with NDAC
21	GND9	Ground wire of twisted pair with IFC
22	GND10	Ground wire of twisted pair with SRQ
23	GND11	Ground wire of twisted pair with ATN
24	GND	Logic Ground

**Table 5-2 : IEEE-488 Pin Designations**

### 5.2.7. IEEE-488 INPUT BUFFERING

The IEEE-488 input buffer is 256 bytes long. The input full bit is set when the buffer is above 75% full (64 bytes remaining), hence if the programmer limits messages sent to the 6530 to 32 bytes and checks the IFL bit in the status register before sending each message, then under normal operating conditions the buffer should never overflow. If the buffer is full and the programmer sends more data, the 6530 will perform the necessary handshaking as per usual, but the data will be lost, this is done for two reasons:

If the buffer is full, the fault must have originated with the controller, since the 6530 interprets most commands in fewer than 15 milliseconds. This prevents the 6530 from locking up the IEEE-488 bus.

### 5.2.8. IEEE-488 OUTPUT BUFFERING

Output from query commands are placed into a 256 byte output buffer. When the controller reads data from the 6530 the responses will come from the output buffer in, first-in first-out order. If for some reason the controller does not read the responses from its query commands the output buffer will overflow, in this case the first data into the buffer will still be valid and the later data will be lost. When output data is lost the query error bit in the status register will be set. When the output buffer is not empty then the message available (MAV) bit will be set in the status register.



### 5.2.9. IEEE-488 DEADLOCK

If the controller demands a byte of data from the 6530 and the buffer is empty, the 6530 will set the Query Error flag in the Event Status Register.

### 5.3. RS-232C INTERFACE

The 6530 has an RS-232C interface which can be connected to a controller or to a simple printer. The controller (which can be almost any computer with an RS-232C interface) can control the 6530 through a variety of commands that allow setting the instruments operating parameters, and analyzing the measurements made by the 6530. The simple printer interface can be used to log any or all of the measurements taken by the 6530 during normal operation.

When using the RS-232C port to remotely control the 6530, either interactively with a terminal or under computer control, operation is the same as using an IEEE-488 controller connected to the IEEE-488 port for control, with the following exceptions:

1. The program message terminator is Carriage Return (0x0D).
2. There is no SRQ capability when using serial remote control. The status registers still behave as described in this chapter, but the 6530 serial interface does not have a way to perform the SRQ function.
3. There is no direct way to perform IEEE-488 hardware interface functions such as DCL (Device Clear) or SDC (Selected Device Clear).

Pin	Name	Function	Direction
1	CHG	Chassis Ground	IN/OUT
2	TxD	Transmit Data	IN
3	RxD	Receive Data	OUT
4	RTS	Request To Send	IN
5	CTS	Clear To Send	OUT
6	DSR	Data Set Ready	OUT
7	GND	Signal Ground	IN/OUT
8	DCD	Data Carrier Detect	OUT
20	DTR	Data Terminal Ready	IN
All other pins not used or connected			

**Table 5-3 : RS232 Pin Designations**

The 6530 Teraohm Bridge-Meter is data communication equipment (DCE) so TxD is an input (the data which the modem is to transmit).

### 5.3.1. RS-232C RESPONSES

The reply to any RS-232C query command will be a sequence of ASCII characters followed by a Carriage-Return character (0x0D) and then a Line-Feed character (0x0A). The Line-Feed character may also be expressed as 0A<sub>16</sub> or 10<sub>10</sub> or 12<sub>8</sub> or Ctrl-J. Throughout this document we will use the "C" programming language notation for expressing numbers in base 16, specifically 0x0A indicates that 0A is to be interpreted in base 16 (hex).

## 5.4. COMMAND LANGUAGE

The commands for IEEE-488 and RS-232C mainly correspond to the labels assigned to the front panel menus. Throughout this document when examples are given, they apply to commands through the RS-232C interface or through the IEEE-488 interface. The examples will not show the termination characters since these differ for each of the interfaces (See Sections 5.2.2 and 5.3.1).

### 5.4.1. GENERAL SYNTAX FOR COMMANDS

The 6530 uses a sophisticated command parser which can usually determine which command was desired, even if the command is entered incorrectly. Some care should be taken when sending commands such as SYSTem:VERBose and SYSTem:VERSion? Since the parser may not be able to decide which command was desired in the event of a gross misspelling (such as using VERBion instead of VERSion).

No command used in the 6530 has an embedded space in its name; spaces (0x20) are used only to separate command names from their parameters.

The comma "," must delimit all multiple arguments used in a command sequence. Throughout this manual some of the command names will have an UPPER case portion and a lower case portion. The command may be shortened such that only the portion of the command name that was presented in UPPER case characters is present. The command parser of the 6530 is case insensitive (i.e. the letter case of commands sent to the 6530 does not matter), both UPPER case letters and lower case letters may be used.

### 5.4.2. GENERAL SYNTAX FOR NUMBERS

Numeric parameters may have up to 30 characters, and although the 6530 will accept numeric parameters in the range  $\pm 2.2\text{E}-308$  through  $\pm 1.8\text{E}308$ , the useful range of numbers is between  $\pm 1.0\text{E}-8$  and  $\pm 1.0\text{E}5$ .

The portion of the command parser that interprets numeric input will correctly recognize most common forms of numeric input, for example the following are all valid methods of expressing the number 123.4:

- 123.4
- 123.4e00
- 0.1234E3
- 1234e-1
- 0000123.4

The following are examples of invalid forms of expressing a number:

- 123.4 e00           space between mantissa and exponent letter
- 1234D-1           exponent not e or E
- n123.4           letter in front of the first digit
- e34               missing mantissa

Multipliers (such as  $\mu$ , m, k, and M) are not permitted on commands, all numbers must be entered in the base units, for example 100 mV can be expressed as 100e-3 or 0.100. Expressions (for example  $7 + 20 \times 3$ ) are not allowed as parameters.

### 5.4.3. REMOTE AND LOCAL OPERATION

The 6530 can be operated using the front panel keys or it can be operated remotely using a remote controller.:

#### 5.4.4. LOCAL

The 6530 responds to local and remote commands. This is also called "Front Panel Operation". Only remote commands that do not affect the state of the 6530 are allowed to execute. (For example the command `SENSe:CAPacitor?` is allowed to operate but the command `SENSe:CAPacitor 27` which would change the instrument state is not allowed.) If the controller sends a command which would affect the instrument state while in local, the command will be ignored, and an Execution Error indication will be given.

### 5.4.5. REMOTE

When the Remote Enable (REN) line is asserted and the controller addresses the 6530 as a listener, the 6530 enters the remote state.

Front panel operation is restricted to the use of the <remote> key. Pressing the <remote> key or sending the GTL (Go To Local) interface message returns the 6530 to the local state.

### 5.4.6. REMOTE WITH LOCKOUT

The remote with lockout state can be entered from remote or local with lockout, but not directly from local. Remote with lockout is similar to the remote state but restricted: the <remote> key will not return to the local state. To return the 6530 to the local state the controller must send a GTL interface command. To return the 6530 to the local state the controller must unassert the REN control line. Table 5-4 summarizes the possible Remote/Local state transitions.

From	To	IEEE-488 Interface Command	RS-232C Interface Command
Local	Remote	MLA + REN	REMOTE
	Remote / Lockout	LLO + REN	LOCKOUT
Remote	Local	GTL	LOCAL
	Remote / Lockout	LLO + REN	LOCKOUT

**Table 5-4 : Remote/Local State Transitions**

## 5.5. PROGRAMMING COMMAND SUMMARY

A brief description of each of the possible remote RS232 and IEEE-488 commands and their syntax in BNF (Backus Naur Form) follows:

- words inside angle brackets (i.e. <digit> ) are defined items
- ::= means "is defined to be"
- {} means "or"
- words inside square brackets (i.e. [+]) means optional
- Required letters are shown in upper case but may be upper or lower case.

<d>	::= {0 1 2 3 4 5 6 7 8 9}	
<l>	::= {A B C ... Z a b c ... z}	
<s>	::= {<l>   <l><s>}	
<b>	::= {0 1}	
<u>	::= {<d>   <d><u>}	
<n>	::= [{+ -}]<u>	
<f>	::= <n>.[.<u>][E<n>]	
<?>	::= {<l>   <d>}	
<*>	::= {<?>   <?><*>}	(not to be confused with *)
<DD>	::= <u>	(limited to range 1...31)
<MM>	::= <u>	(limited to range 1...12)
<YYYY>	::= <u>	(limited to ranges 0...38 and 2000...2038)
<hh>	::= <u>	(limited to range 0...23)
<mm>	::= <u>	(limited to range 0...59)
<ss>	::= <u>	(limited to range 0...59)

## SCPI Specification for 6530

### 5.5.1. Standard System Commands

*CLS	; clear event status register, empty input queue
*ESE <enable value (no units)>	; clear event status register, empty input queue
*ESE?	; report event status enable
*ESR?	; report event status register
*IDN?	; report identity of unit
*OPC	; set operation complete bit in event status register
*OPC?	; report operation complete
*OPT?	; report any reportable options
*RST	; reset the instrument to a known defined state
*SRE <enable value (no units)>	; set the service request mask
*SRE?	; report service request mask
*STB?	; report status byte
*TRG	; trigger the next reading when in BUS mode
*TST?	; report results of self test
*WAI	; wait for pending operations to complete

## System Commands

SYSTem:ATMospheric:PRESSure?

SYSTem:CHECK:SUM?

SYSTem:COMMunications:GPIB <address>, TALK Only | TALK Listen | DISable

address 0-31

:GPIB?

SYSTem:COMMunications:SERial <baud>, <data>, <stop>, <parity>, <echo>,  
<flow control>, <mode>

baud 1200 | 2400 | 4800 | 9600 | 19200 | 38400

databits 7 | 8

stop 1 | 2

parity NONE | ODD | EVEN

echo ON | OFF

flowcontrol NONE | XON | RTS

mode TALK Only | TALK Listen | DISable

:SERial?

SYSTem:DATE <YYYY, MM, DD>

:DATE?

SYSTem:HUMidity?

SYSTem:KEY?

SYSTem:MODE NATIVE | TRACE

:MODE?

SYSTem:STATe LOCAL | REMote | LOCKout

:STATe?

SYSTem:SERial:NUMBer <value>

:SERial:NUMBer?

SYSTem:TEMPerature?

SYSTem:TIME <hh,mm,ss>  
:TIME?

SYSTem:TERSe

SYSTem:VERBoSe

SYSTem:VERSiOn?

## 5.5.2. Calibration Commands

CALibration:CAPacitor 27 | 270 | 2700 , <calibration coefficient (ppm)>  
:CAPacitor?

CALibration:DATE <yyyy,mm,dd,hh,mm,ss>  
:DATE?

CALibration:OUTPut:VOLTage +1 | +2 | +5 | +10 | +20 | +50 | +100 | +200 | +500 | +1000 |  
-1 | -2 | -5 | -10 | -20 | -50 | -100 | -200 | -500 | -1000 ,  
<calibration coefficient (ppm)>  
:OUTPut:VOLTage?

CALibration:PARAmeters:PROTection <variance (ppm)> , <standard deviation (ppm)> ,  
<sample size> , <maximum sample count>

:PARAmeters:PROTection?

CALibration:PARAmeters:RESistor  
<variance (ppm)> , <std dev (ppm)> , <sample size> , ; 27pF  
<variance (ppm)> , <std dev (ppm)> , <sample size> , ; 270pF  
<variance (ppm)> , <std dev (ppm)> , <sample size> , ; 2700pF  
<variance (ppm)> , <std dev (ppm)> , <sample size> , ; 0.1V  
<variance (ppm)> , <std dev (ppm)> , <sample size> , ; 1.0V  
<maximum sample count>

:PARAmeters:RESistor?

CALibration:PROTection:RESistor <value> ; 80K – 120K  
:PROTection:RESistor?



CALibration:REFerence:RESistor <value> ; 80M - 12G  
:REFerence:RESistor?

CALibration:SERial:NUMber <string> ; maximum length is 20  
:SERial:NUMber?

CALibration:SPEC:CLEar

CALibration:SPEC?

CALibration:THReshold:VOLTagE 0.1 | 1.0, <calibration coefficient (ppm)>  
:THReshold:VOLTagE?

CALibrate:SYSTem:COEFFicient <nominal value>, <volts>, <pos coefficient>, <neg coefficient>  
:SYSTem:COEFFicient? <nominal value>, <volts>

CALibrate:SYSTem:PARAmeters <nominal value>, <volts>, <sample count>, <sample size>, <sample window>  
:SYSTem:PARAmeters? <nominal value>, <volts>

### 5.5.3. Configuration Commands

CONFigure:TEST:VOLTagE START | CONTInue | DISable

### 5.5.4. Measurement Commands

MEASure ON | OFF  
MEASure?

MEASure:UNITs OHMS | AMPS | SURFACE resistivity | VOLume Resistivity  
:UNITs?

MEASure:WINDow <value> ; MEAS:REV:COUNT \* 2  
:WINDow?

MEASure:REVersal:COUNT <value> ; 1 – 50 if MEAS:WINDOW > 0 else > 0  
REVersal:COUNT?

MEASure:TERA:COUNT <value> ; 0 – 500  
TERA:COUNT?

MEASure:TERA:SIZE <value> ; MEAS:TERA:COUNT - 2

MEASure:TERA:SIZE?

MEASure:TERA:THReshold  
:TERA:THReshold? <value> ; 0.0 – 0.9e+15

MEASure:STABilize:SIZE  
:STABilize:SIZE? <value> ; 0 – 100

READ:RESistance?

READ:CURRent?  
:SURface:RESistivity?  
:VOLume:RESistivity?

SENSE:ATMospheric:PRESSure?

SENSE:CAPacitor  
:CAPacitor? 27 | 270 | 2700

SENSE:HUMidity?

SENSE:INTegration:TIME?

SENSE:INTegrator:THReshold  
:THReshold? 0.1 | 1.0 | 10.0

SENSE:MAXimum:VOLTage  
:VOLTage? 1 | 3 | 10 | 30 | 100 | 300 | 1000

SENSE:OUTput:VOLTage  
:VOLTage? 1 | 3 | 10 | 30 | 100 | 300 | 1000

SENSE:POLarity  
:POLarity? POSitive | NEGative | AUTO

SENSE:RANGE  
:RANGE? AUTO | MANual

SENSE:REMote:INTerlock  
SENSE:REMote:INTerlock? ON | OFF

SENSE:RESistivity:THICKness  
:THICKness? <value>

SENSe:RESistivity:AREA <value>  
:AREA?

SENSe:RESistivity:PERimeter <value>  
:PERimeter?

SENSe:RESistivity:DISTance <value>  
:DISTance?

SENSe:TEMPerature?

### 5.5.5. Trace Commands

TRACe:CLEAr

TRACe:DATA? ; dump buffer

TRACe:DIAGnostics ON | OFF | SENSORS  
:DIAGnostics?

TRACe:ELEMents TIMEstamp , HUMidity , TEMPerature , ATMOSpheric Pressure , NONE  
, ALL , RELative Time , RTClock  
:ELEMents?

TRACe:MODE CLEAR | PROMPT | KEEP  
:MODE?

TRACe:TREND:DATA? ; dump summary buffer

TRACe:TREND:SUM? ; dump summary statistics

TRACe:TREND:CLEAr ; clear summary statistics

TRACe:TSTamp:TYPE RELative | RTClock  
:TSTamp:TYPE?



### 5.6. REMOTE COMMANDS

This section details all the valid commands that may be sent over either the IEEE-488 or the RS-232C interface port. The responses listed below are the verbose response.

If the numeric parameter to the command is missing or unrecognizable the CME (CoMmand Error) bit in the Event Status Register (see Figure 5-1) will be set. If the unrecognizable command was sent over the RS-232C interface, the 6530 will respond with “Unrecognized Command”.

If the numeric value is out of range, then the EXE (EXecution Error) bit will be set for a program data element out of range error. If the out of range value was sent over the RS-232C interface, the 6530 will respond with “Invalid Parameter”.

Unless otherwise indicated, the terse response is that portion of the response printed in bold.

#### 5.6.1. \*CLS - CLEAR STATUS COMMAND

This command clears all Event Status Registers summarized in the status byte register. All queues, except the Output Queue, that are summarized in the status byte register are emptied. The 6530 is forced into the Operation Complete Idle State and the Operation Complete Query Idle state.

#### 5.6.2. \*ESE <u> - SET EVENT STATUS ENABLE REGISTER

This command sets the standard event status enable register bits. When the bits in the Event Status Enable (ESE) register are "ANDed" with the bits in the Event Status Register (ESR) if the result is non-zero then the Event Status Bit (ESB) in the Status Byte (STB) register is set.

The values accepted for the \*ESE command are between 0 and 255, all other values are considered to be an error. The default value for the Event Status Enable (ESE) register at power on is zero (0).

#### 5.6.3. \*ESE? - EVENT STATUS ENABLE QUERY

This command reports the current value of the Event Status Enable Register. The value returned will be between 0 and 255.

#### 5.6.4. \*ESR? - EVENT STATUS REGISTER QUERY

This query allows the programmer to determine the current contents of the event status register. Reading the Event Status Register clears it.

Bit	Location	Name	Description
0	LSB	OPC	Operation Complete. This event bit is generated in response to the *OPC or *OPC? command. It indicates that the 6530 has completed any pending operations and that the parser is ready to accept more program messages.
1		RQC	ReQuest Control. This event bit indicates to the GPIB controller that the 6530 is requesting permission to become the controller in charge. The 6530 will never set this bit.
2		QYE	QuerY Error. This bit indicates that an attempt is being made to read data from the output queue when no output is either present or pending, or that data in the output queue has been lost (queue over-flow). See also GPIB Deadlock.
3		DDE	Device Dependent Error. Not Used.
4		EXE	EXecution Error. Set when (1)a program data element is evaluated to be outside the legal input range or is inconsistent with the 6530's capabilities, (2)a valid program message could not be properly processed.
5		CME	CoMmand Error. Set when (1)a syntax error has been detected by the parser, (2)a semantic error has occurred indicating that an unrecognized header has been received, (3)A Group Execute Trigger was entered into the input buffer inside a program message.
6		URG	User Request. Set when any key is depressed on the 6530 keyboard.
7	MSB	PON	Power ON. This bit is set after the 6530 is powered up.

**Table 5-5 : Event Status Register**

### 5.6.5. \*IDN? - IDENTIFICATION QUERY

This command causes the 6530 to reply with an identification string. The identification string is built up of four (4) fields delimited by commas (.). The first field is the manufacturer (i.e. Guildline Instruments), the second field is the model (i.e. 6530), the third field is the serial number (i.e. 55065), and the final field is the firmware revision (i.e. E). A typical response might read:

**Guildline Instruments, 6530, 55065, E**

### 5.6.6. \*OPC - OPERATION COMPLETE

This command will cause the 6530 to set the Operation Complete bit (bit 0) in the Event Status Register. Since the 6530 processes all commands sequentially, the operation complete bit will be set as soon as the command is parsed.

### 5.6.7. \*OPC? - OPERATION COMPLETE QUERY

This query will place a numeric 1 in the output buffer indicating that all pending operations are complete.

### 5.6.8. \*OPT? - REPORT AVAILABLE OPTIONS

This query command reports the presence or absence of various options. The format of the reply is a series of arbitrary ASCII response fields separated by commas. The 6530 will always report the value 0.

### 5.6.9. \*RST - DEVICE RESET

This command is intended to return the 6530 to a known state, specifically a return to terse mode. This command will not affect the following:

1. The output queue.
2. The state of the IEEE-488 interface.
3. The selected address of the 6530.
4. The \*SRE setting.
5. The \*ESE setting.
6. Calibration data that affects device specifications.

The \*RST command will perform the following actions:

Clear the key-press buffer.

Make remote responses terse.

Set the measurement units to degrees Celsius.

Set the measurement display to the Aux Channel.

\*RST is a MANDATORY IEEE-488.2 command.

### 5.6.10. \*SRE <u> - SERVICE REQUEST ENABLE COMMAND

The service request enable command allows the 6530 to generate a service request on the IEEE-488 interface under a limited set of conditions. The limitations on the conditions are defined by the numeric parameter following the \*SRE command. The numeric parameter is a decimal integer in the range 0-255. The numeric parameter when expressed in base 2 (binary) represents the bit values of the Service Request Enable Register. For all bits (except bit 6) a bit value of one (1) indicates an enabled condition and a bit value of zero (0) represents a disabled condition. \*SRE? is the companion query command.

### 5.6.11. \*SRE? - SERVICE REQUEST ENABLE QUERY

This command allows a programmer to determine the current contents of the Service Request Enable Register. A decimal number between 0 and 63 or between 128 and 191 will be returned.

### 5.6.12. \*STB? - STATUS BYTE QUERY

This command allows the programmer to read the status byte and master summary bits (shown in Table 5-6.).

Bit	Location	Name	Description
0	LSB	INT	Interlock status. 0=enabled, 1=disabled.
1		RDY	Reading complete.
2		min_max	Minimum/Maximum timeout error if set.
3		IFL	Input Full. This bit is set when the input queue is over 75% full and cleared when the queue drops below 25% full.
4		MAV	Message Available. This bit is set when the output queue is not empty.
5		ESB	Event Summary Bit. This bit is set when the result of a bitwise AND of the Event Status Enable register is not zero.
6		RQS	ReQuest for Service. This bit is set when the result of a bit-wise AND of the Status Byte Register and the Service Request Enable register is not zero.
7	MSB	RES	Resistivity Input. 0=volume, 1=surface.

**Table 5-6 : Status Byte Register**

The response from this command is a decimal integer in the range 0-255. This decimal integer when expressed in base 2 (binary) represents the bit values in the Status Byte Register. Note that the Master Summary Status bit and Not RQS is reported in bit 6.

The Status Byte Register can also be read with the Read Serial Poll hardware command on the IEEE-488 interface.

This Register can be read by Serial Poll or by the \*STB? command.

### 5.6.13. \*TST? - QUERY RESULTS OF SELF TEST

This command is intended to report the status of any self-tests performed by the 6530. If the 6530 passes all of its self-tests then the reply will be 0.

The possible failure codes are:

Error Status. Bit 0 – Non-Volatile checksum failure

Bit 1 – Rom checksum failure. Could be ROM/Aux ROM.

Bit 2 – Analog failure.

Bit 3 - +5 volts

Bit 4 - -5 volts

Bit 5 - +15 volts

Bit 6 - -15 volts

Bit 7 – Precharge

Bit 8 – High voltage monitor

Bit 9 – 10 volt reference

Bit 10 - Ramp

Bit 11 – Digital failure.

Bit 12 - +5 volts

Bit 13 - -5 volts

Bit 14 - +15 volts

Bit 15 - -15 volts



## 5.6.14. \*WAI - WAIT-TO- CONTINUE COMMAND

This command is intended to suspend the execution of any further commands until all pending operations have been completed. Since the 6530 does not implement a new command until the last operation has been completed, this command has no effect. It is included in the list of remote commands because it is a mandatory IEEE-488.2 command.

## 5.6.15. SYSTem:ATMospheric:PRESSure? – DISPLAY ATMOSPHERIC PRESSURE

**Typical response:** 104

## 5.6.16. SYSTem:CHECK:SUM? – DISPLAY CHECKSUMS

This command displays the ROM checksum, the AUX ROM checksum and the Non-Volatile SRAM checksum.

**Typical response:** 17574, -12954, 1065

## 5.6.17. SYSTem:COMMunications:GPIB – UPDATE GPIB CONFIG

<address>, <mode>

address0-31

mode TALK Only | TALK Listen | DISable

If Disable is selected then GPIB will not work until it has been enabled by the RS232 serial interface or the Instrument.

Talk Only will output measurement values as well as the selected trace elements (i.e. Humidity) to the GPIB interface.

## 5.6.18. SYSTem:COMMunications:GPIB?

**Typical response:** 4, Talk Listen

## 5.6.19. SYSTem:COMMunications:SERial

<baud>, <data>, <stop>, <parity>, <echo>, <flow control>, <mode>

baud 1200 | 2400 | 4800 | 9600 | 19200 | 38400 | 115200

databits 7 | 8

stop 1 | 2

parity NONE | ODD | EVEN

echo ON | OFF

flowcontrol NONE | XON | RTS

mode TALK Only | TALK Listen | DISable

Talk Only will output measurement values as well as the selected trace elements (i.e. Temperature) to the RS232 interface.

N.B. Use of this command from the remote RS232 interface will change the configuration immediately. This will require the Remote Communications package which you are using to also be reconfigured to comply with your changes.

### **5.6.20. SYSTem:COMMunications:SERial?**

**Typical response:** 9600, 8, 1, None, On, None, Talk Only

### **5.6.21. SYSTem:DATE – UPDATE SYSTEM DATE**

<YYYY, MM, DD>

YYYY (limited to ranges 0...38 and 2000...2038)  
MM (limit range to 1...12)  
DD (limit range to 1...31)

### **5.6.22. SYSTem:DATE? – DISPLAY SYSTEM DATE**

**Typical response:** 2003, 08, 22

### **5.6.23. SYSTem:HUMidity? – DISPLAY HUMIDITY**

**Typical response:** 45

### **5.6.24. SYSTem:KEY? – DISPLAY LAST KEY STROKE**

**Typical response:** 4, e, 2

### **5.6.25. SYSTem:MODE – SET SYSTEM MODE**

NATIVE | TRACE

### **5.6.26. SYSTem:MODE? – DISPLAY SYSTEM MODE**

**Typical response:** NATIVE

### **5.6.27. SYSTem:SERial:NUMBer – SET SYSTEM SERIAL NUMBER**

<value>

value (limit range to 0...99999)

### **5.6.28. SYSTem:SERial:NUMBer? – DISPLAY SYSTEM SERIAL NUMBER**

**Typical response:** 67630

### **5.6.29. SYSTem:STATe - UPDATE SYSTEM STATE**

LOCAL | REMote | LOCKout

### **5.6.30. SYSTem:STATe? – DISPLAY SYSTEM STATE**

**Typical response:** LOCAL

### **5.6.31. SYSTem:TEMPerature? – DISPLAY TEMPERATURE**

**Typical response:** 23

### **5.6.32. SYSTem:TERSe – SET SYSTEM TO TERSE**

Set the system to only display data on responses. (no text description)

### **5.6.33. SYSTem:TIME – SET SYSTEM TIME**

<hh, mm, ss>

hh (limit range to 0...23)

mm (limit range to 0...59)

ss (limit range to 0...59)

### **5.6.34. SYSTem:TIME? – DISPLAY SYSTEM TIME**

**Typical response:** 15, 10, 20

### **5.6.35. SYSTem:VERSion? – DISPLAY SYSTEM VERSION**

**Typical response:** 2

### **5.6.36. SYSTem:VERBoSe – SET SYSTEM TO VERBOSE**

Set the system to display a text description of displayed responses.

### **5.6.37. CALibration:CAPacitor – UPDATE COEFFICIENT**

27 | 270 | 2700, <error coefficient (ppm)>

The error coefficient is a long integer and cannot exceed  $\pm 100,000$ .

### **5.6.38. CALibration:CAPacitor? – DISPLAY COEFFICIENTS**

This will display all three (3) capacitors and their coefficients.

**Typical response:** 27pf, 21254 270pf, -9871, 2700pf, 12926

### **5.6.39. CALibration:DATE – UPDATE LAST CALIBRATION DATE**

<YYYY, MM, DD, hh, mm, ss>

This is the date and time of the last calibration which was done on the instrument.

## 5.6.40. CALibration:DATE? – DISPLAY LAST CALIBRATION DATE

**Typical response:** 2003, 08, 21, 15, 30, 0

## 5.6.41. CALibration:OUTPut:VOLTagE – UPDATE COEFFICIENTS

+1 | +3 | +10 | +30 | +100 | +300 | +1000 |  
 -1 | -3 | -10 | -30 | -100 | -300 | -1000, <error coefficient (ppm)>

The error coefficient is a long integer and cannot exceed  $\pm 100,000$ .

## 5.6.42. CALibration:OUTPut:VOLTagE? – DISPLAY COEFFICIENTS

**Typical response:**

-1 V, 1.000189  
 -3 V, 3.000033  
 -10 V, 9.999963  
 -30 V, 29.99993  
 -100 V, 100.0014  
 -300 V, 299.9957  
 -1000 V, 999.916  
 +1 V, .999921  
 +3 V, 2.999948  
 +10 V, 9.999989  
 +30 V, 29.99966  
 +100 V, 99.9994  
 +300 V, 299.9964  
 +1000 V, 999.929

## 5.6.43. CALibration:PARAmeters:PROTection

<variance (ppm)> , ; 1.0 – 1000.0  
 <standard deviation (ppm)> , ; 1.0 – 250.0  
 <sample size> , ; 25 - 500  
 <maximum sample count> ;  $\geq 125$

## 5.6.44. CALibration:PARAmeters:PROTection?

**Typical response:** 200.00 , 100.00 , 25 , 1000

## 5.6.45. CALibration:PARAmeters:RESistor

### 27 pF Capacitor

<variance (ppm)> , ; 1.0 – 1000.0  
 <standard deviation (ppm)> , ; 0.01 – 250.0  
 <sample size> , ; 25 – 500

### 270 pF Capacitor

<variance (ppm)> , ; 1.0 – 1000.0  
 <standard deviation (ppm)> , ; 0.01 – 250.0  
 <sample size> , ; 25 – 500

### 2700 pF Capacitor

<variance (ppm)> , ; 1.0 – 1000.0  
 <standard deviation (ppm)> , ; 0.01 – 250.0  
 <sample size> , ; 25 – 500

### 0.1 V Threshold

<variance (ppm)> , ; 1.0 – 1000.0  
 <standard deviation (ppm)> , ; 0.01 – 250.0  
 <sample size> , ; 25 - 500

### 1.0 V Threshold

<variance (ppm)> , ; 1.0 – 1000.0  
 <standard deviation (ppm)> , ; 0.01 – 250.0  
 <sample size> , ; 25 - 500

<maximum sample count> ; >= 125

## 5.6.46. CALibration:PARAmeters:RESistor?

**Typical response:** 3.00 , 0.75 , 100 , 7.00 , 2.00 , 60 , 3.00 , 1.50 , 30 , 7.00 , 2.00 , 100 , 2.00  
 , 0.75 , 60 , 3000

## 5.6.47. CALibration:PROTection:RESistor

<value> ; 80K – 120K

**5.6.48. CALibration:PROTection:RESistor?**

Typical response: 100083

**5.6.49. CALibration:REFeRence:RESistor**

<value> ; 80M - 12G

**5.6.50. CALibration:REFeRence:RESistor?**

Typical response: 100001800

**5.6.51. CALibration:SERial:NUMBer**

<string> ; maximum length is 20

**5.6.52. CALibration:SERial:NUMBer?**

Typical response: 62153

**5.6.53. CALibration:SPEC:CLEar**

**5.6.54. CALibration:SPEC?**

Typical response:

```
"Date",,"Coefficient","Count","Sample","Variance","Std
Dev",,"Temperature","Humidity","Atmospheric Pressure"
2005/03/31 05:03:12, 27pF,-22926,97,30,26.389,7.951, 0.0, 0.0, 0.0
2005/03/30 22:41:39, 27pF,-22908,111,30,21.759,6.067, 0.0, 0.0, 0.0
2005/03/31 04:36:20, 270pF,6298,88,30,21.991,5.333, 0.0, 0.0, 0.0
2005/03/30 22:10:54, 270pF,6345,93,30,13.519,3.062, 0.0, 0.0, 0.0
2005/03/31 04:08:42,2700pF,6951,142,30,4.528,1.216, 0.0, 0.0, 0.0
2005/03/30 21:41:42,2700pF,6972,76,30,3.245,0.972, 0.0, 0.0, 0.0
2005/03/31 05:32:57, 0.1V,161,30,30,117.470,35.551, 0.0, 0.0, 0.0
2005/03/30 23:27:34, 0.1V,150,44,30,114.250,33.791, 0.0, 0.0, 0.0
2005/03/31 05:24:35, 1.0V,1,68,30,19.678,5.378, 0.0, 0.0, 0.0
2005/03/30 23:15:18, 1.0V,-4,107,30,16.896,4.242, 0.0, 0.0, 0.0
```

**5.6.55. CALibration:SYSTem:COEFficient**

<nominal value>, <volts>, <pos coefficient>,>, <neg coefficient>

### 5.6.56. CALibration:SYSTEM:COEFFicient?

**Typical response:** 90k to 200k, 1V, 273,273

### 5.6.57. CALibration:SYSTEM:PARAmeters

<nominal value>, <volts>, <sample count>, <sample size>, <sample average>,<sample window>

### 5.6.58. CALibration:SYSTEM:PARAmeters?

**Typical response:** 90k to 200k, 1V, 90, 100, 1, 2

### 5.6.59. CALibration:SYSTEM:REV

<user rev>

### 5.6.60. CALibration:SYSTEM:REV?

**Typical response:** <user rev> / <system rev>

### 5.6.61. CALibration:THREshold:VOLTage

0.1 | 1.0 <calibration coefficient (ppm)>

### 5.6.62. CALibration:THREshold:VOLTage?

**Typical response:** 0.1V, 37, 1.0V, -160

### 5.6.63. CONFigure:TEST:VOLTage

START | CONTInue | DISable

When the system is in remote or lockout then it is necessary to send a <CONTInue> command within twenty (20) seconds when measuring resistance or resistivity. This is a safety precaution to prevent the high voltage section from remaining active when the remote controlling device is not in a known operating state.



### 5.6.64. MEASure – START/STOP MEASUREMENT

ON | OFF

This is used to start or stop a measurement from a remote device (RS232 or GPIB)

### 5.6.65. MEASure?

**Typical response:** Off

### 5.6.66. MEASure:UNITS – SET CURRENT MEASUREMENT MODE

OHMS | AMPS | SURFACE resistivity | VOLume Resistivity

### 5.6.67. MEASure:UNITS? – DISPLAY MEASUREMENT MODE

**Typical response:** Ohms

### 5.6.68. READ:RESistance?

**Typical response:** 1.13499232e+16

### 5.6.69. READ:CURRent?

**Typical response:** 1.13499232e+16

### 5.6.70. READ:SURFace:RESistivity?

**Typical response:** 1.13499232e+16

### 5.6.71. READ:VOLume:RESistivity?

**Typical response:** 1.13499232e+16

### 5.6.72. SENSE:ATMospheric:PRESSure?

**Typical response:** 101.2

### 5.6.73. SENSE:CAPacitor – SET CURRENT CAPACITOR

27 | 270 | 2700

### **5.6.74. SENSE:CAPacitor? – DISPLAY CURRENT CAPACITOR**

**Typical response:** 2700pf

### **5.6.75. SENSE:HUMidity?**

**Typical response:** 80

### **5.6.76. SENSE:INTEgration:TIME?**

**Typical response:** 1.1036

This is the time in seconds that it took to take the last measurement.

### **5.6.77. SENSE:INTEGrator:THREShold**

0.1 | 1.0 | 10.0

### **5.6.78. SENSE:INTEgrator:THREShold?**

**Typical response:** 10.0V

### **5.6.79. SENSE:MAXimum:VOLTage**

1 | 3 | 10 | 30 | 100 | 300 | 1000

### **5.6.80. SENSE:MAXimum:VOLTage?**

**Typical response:** 1V

### **5.6.81. SENSE:OUTput:VOLTage**

1 | 3 | 10 | 30 | 100 | 300 | 1000

### **5.6.82. SENSE:OUTput:VOLTage?**

**Typical response:** 10V

### **5.6.83. SENSE:POLarity**

POSitive | NEGative | AUTO

### 5.6.84. SENSE:POLarity

**Typical response:** Auto

### 5.6.85. SENSE:RANGe

AUTO | MANual

### 5.6.86. SENSE:RANGe?

**Typical response:** Auto

### 5.6.87. SENSE:REMote:INterlock

ON | OFF

This will enable or disable the interlock function while controlling the 6530 remotely.

### 5.6.88. SENSE:REMote:INterlock?

**Typical response:** ON

### 5.6.89. SENSE:RESistivity:THICkness

<value>

This is the thickness of the material being measured. It should be entered in either inches or centimeters depending on the current resistivity unit.

### 5.6.90. SENSE:RESistivity:THICkness?

**Typical response:** 0.125

### 5.6.91. SENSE:RESistivity:AREA

<value>

This is the area coefficient. It is normally zero (0) but can be set to another value if you are using the custom mode of measuring resistivity.

### 5.6.92. SENSE:RESistivity:AREA?

**Typical response:** 0.0

### 5.6.93. SENSE:RESistivity:PERimeter

<value>

This is the perimeter. It is normally set to 0.125 if unit is inches but can be set to another value if you are using the custom mode of measuring resistivity.

### 5.6.94. SENSE:RESistivity:PERimeter?

**Typical response:** 0.125

### 5.6.95. SENSE:RESistivity:DISTance

<value>

This is the distance. It is normally set to 0.125 if unit is inches but can be set to another value if you are using the custom mode of measuring resistivity.

### 5.6.96. SENSE:RESistivity:DISTance?

**Typical response:** 0.125

### 5.6.97. SENSE:TEMPerature?

**Typical response:** 23.1

### 5.6.98. TRACe:CLEAr – CLEAR DETAIL TRACE BUFFER

This will clear the detail trace buffer and the detail totals of the summary.

### 5.6.99. TRACe:DATA? – DUMP TRACE BUFFER

**Typical response:**

```
1.13499232e+16,2003/07/30 10:28:04,82, 22.1, 80.0, 101.0,27pf,0.1V,Auto,1000  
1.13953412e+16,2003/07/30 10:33:54, 5, 22.4, 80.1, 101.2,27pf,0.1V,Auto,1000
```

### 5.6.100.TRACe:DIAGnostics

ON | OFF | SENSORS

This is normally set to off. <On> provides a means to automatically output the Digital Diagnostics or the Analog Diagnostics to the remote device as well as the display while this diagnostic is running. <Sensors> adds the state of the internal instrument temperature to the remote trace data when the remote device is set to Talk Only.

### 5.6.101.TRACe:DIAGnostics?

**Typical response:** Off

### 5.6.102.TRACe:MODE

CLEAR | PROMPT | KEEP

This is normally set to KEEP which will retain the data stored in the trace buffer upon the start of a new measurement. <CLEAR> provides a means to automatically clear the trace buffer upon the start of a new measurement. <PROMPT> will prompt the user upon the start of a new measurement asking to “Clear” or “Keep” the trace buffer data. While in remote this mode assumes “Keep”.

### 5.6.103.TRACe:MODE?

**Typical response:** Keep

### 5.6.104.TRACe:ELEMents

TIMEstamp , HUMidity , TEMPerature , ATMOSpheric Pressure , NONE , ALL ,  
RELative Time , RTClock

### 5.6.105.TRACe:ELEMents?

**Typical response:** None

### 5.6.106.TRACe:TREND:DATA? – DUMP SUMMARY BUFFER

### 5.6.107.TRACe:TREND:SUM? - DUMP SUMMARY STATISTICS

### 5.6.108.TRACe:TREND:CLEAr – CLEAR SUMMARY STATISTICS

This will clear the summary trace buffer and the summary totals.

### 5.6.109.TRACe:TSTamp:TYPE

RELative | RTClock

This allows the time of each entry in the trace buffer to be displayed either as the date and time or as relative time from the last <TRACe:CLEar> command or the last detail clear on the instrument.

### 5.6.110.TRACe:TSTamp:TYPE?

**Typical response:** RTClock

### 5.6.111.TRIGger:SOURce

MANual | BUS | EXTernal | CONTInuous

<BUS> is used if individual measurements wish to be controlled with the <\*TRG> remote command.

### 5.6.112.TRIGger:SOURce?

**Typical response:** Continuous

### 5.6.113.TRIGger:DELay

<value> ; 0-999999.999 seconds

This allows the instrument to provide any internal delay between each measurement. It is normally set to zero (0) but is used to create a delay between measurements especially if they are very fast measurements.

### 5.6.114.TRIGger:DELay?

**Typical response:** 0.0

### 5.6.115.TRIGger:SOAK

<value> ; 0-999999.999 seconds

This allows the instrument to allow additional settling time between reversals of polarity.

### **5.6.116.TRIGger:SOAK?**

**Typical response:** 0.0

### **5.6.117.TRIGger:SENSor:TIMer**

<value> ; 0-999 seconds

This sets the rate for the instrument to take automatic readings of the Temperature, Humidity and Atmospheric Pressure. It is normally set to three (3) seconds.

### **5.6.118.TRIGger:SENSor:TIMer?**

**Typical response:** 3





## 6. VERIFICATION AND CALIBRATION

### 6.1. CALIBRATION DESCRIPTION

The procedure outlined in this section may be used to perform system verification of the 6530 TeraOhm Bridge-Meter for proper operation. This verification procedure may be performed when the instrument is first received to ensure that no damage or maladjustment has occurred during shipment.

#### 6.1.1. ENVIRONMENTAL CONDITIONS

Verification checks should be made only when the instrument is being operated within the operating limits of temperature and humidity specified in Section 8 of this manual.

#### 6.1.2. INITIAL CONDITIONS

A warm-up time of at least four hours must be allowed before beginning the verification process. If the instrument has been subjected to extremes of temperature outside the operating limits, additional time should be allowed for the instrument components to stabilize to their normal operating temperatures. Typically, it takes one additional hour to stabilize a unit that has been exposed to a temperature 10°C outside the specified temperature range.

#### 6.1.3. RECOMMENDED TEST EQUIPMENT

Table 6-1 lists all test equipment required for the verification of the 6530 TeraOhm Bridge-Meter. Alternate equipment may be used if the substitute equipment has specifications as good as or better than the equipment listed.

Description	Minimum Use Specifications	Recommended Equipment
Output Voltage	Range (0 to $\pm 1000$ ) DC V, accuracy $\pm 0.1\%$ of output	DC V Meter accuracy < 60 ppm or better, minimum 10 M $\Omega$ input impedance

**Table 6-1: Recommended Verification Test Equipment**

#### 6.1.4. CHECK CALIBRATION REPORT

The following paragraph details the procedures to be used to check the stored calibration coefficients against the coefficients listed on the instrument calibration report. If the instrument has been re-calibrated or adjustments made to the instrument after the date printed on the calibration report, the stored coefficients may not match the coefficients listed in the report. The user should verify the instrument against the most recent calibration report.

## 6.1.4.1. CALIBRATION COEFFICIENTS

- Reference should be made to Section 6.5.2
- Apply power to the instrument
- Verify that the unit passes all self-tests
- Press the <SOFCAL> key
- Press the <Calibrate> key
- Press the <Ref Vals> key
- Press the <Serial Num> key
- Verify that the serial number displayed matches the serial number printed on the rear of the instrument and on the instrument calibration report.
- Press the <PREVIOUS> key to exit to the Calibrate menu
- Press the <PREVIOUS> key to exit to the Sofcal menu
- Press the <User> key to enter the User menu
- Press the <Err Coeff> key to enter the Error coefficients menu
- Verify the error displayed for each test voltage matches the value listed in the calibration report
- Verify the error displayed for the ZERO COEFFICIENT matches the value listed in the calibration report
- Verify the error displayed for the CAPACITOR COEFFICIENTS matches the values listed in the calibration report
- Verify the error displayed for the THRESHOLD COEFFICIENTS matches the values listed in the calibration report
- Press the <PREVIOUS> key to exit to the User menu
- Press the <PREVIOUS> key to exit to the Sofcal menu

## 6.1.5. TEST VOLTAGE VERIFICATION

Connect the Digital Voltmeter to the SOURCE connector of the 6530 under test.

Put the instrument into the SOFCAL DIAGNOSTIC MENU

Select <Volt Test> function key to perform Voltage Test.

Use the Up/Down arrow keys to select the +1 V test voltage.

Press the <Volts On> key to turn the SOURCE output on.

Record the reading displayed by the DC V Meter. Press the <Down Arrow> key to select the next test voltage. Record each test voltage nominal value (Vnom) and the DC V reading (Vdvm) for each test voltage (+1 V through +1000 V and -1 V through -1000 V). Press the <Volts Off> key to turn the SOURCE output OFF. Calculate the test voltage error value from the following expression:

$$\text{Error (ppm)} = \frac{V_{\text{dvm}} - V_{\text{report}}}{V_{\text{nom}}} \times 10^6$$

Use the absolute value of  $V_{dvm}$  and  $V_{report}$ . For each test voltage verify that the Error (ppm) does not exceed the  $\pm 50$  ppm of the listed value in the calibration report (Table 6-3).

### **6.1.6. OPERATIONAL CHECK**

Performing an instrument Power On Reset and observing the response can check the operation of the TeraOhm Bridge-Meter display and indicators. The TeraOhm Bridge-Meter will respond as detailed in Section 4.2. Power “On” the instrument and observe that the instrument responds to the series of internal diagnostic checks as detailed in Section 4.2

## **6.2. CALIBRATION PROCEDURE**

The procedure outlined in this section may be used to perform an Artifact Calibration on the 6530 TeraOhm Bridge-Meter to remove the effect of long-term drift associated with capacitor and thresholds in the electrometer. This process ensures the base current measurement of the electrometer operates within the limits stated in the specifications (Section 8) of this manual. This calibration procedure should be executed on an annual basis as a minimum to maintain full rated 12-month accuracy when the 6530 is used for current measurements. A full resistance confirmation of the 6530 should be performed after the artifact calibration as this, DOES AFFECT THE RESISTANCE OPERATION, or whenever there is a question of instrument accuracy. Full performance confirmation and any subsequent adjustments, though recommended to be performed at the factory, may be performed by a qualified individual as per the procedure outlined in the Service Manual (SM6530). This manual can be obtained from Guildline Instruments Limited. A brief description of the Calibration and Instrument theory can be found in Section 6.4.

### **6.2.1. ENVIRONMENTAL CONDITIONS**

Calibration of the instrument should only be performed while the 6530 is being operated within the operating limits of temperature and humidity specified in Section 8 of this manual.

### **6.2.2. INITIAL CONDITIONS**

A warm-up time of at least one hour must be allowed before beginning the verification process. If the instrument has been subjected to extremes of temperature outside the operating limits, additional time should be allowed for the instrument components to stabilize to their normal operating temperatures. Typically, it takes one additional hour to stabilize a unit that has been exposed to a temperature  $10^{\circ}\text{C}$  outside the specified temperature range.

### 6.2.3. RECOMMENDED TEST EQUIPMENT

Table 6-2 lists all test equipment required for the Artifact Calibration of the 6530 TeraOhm Bridge-Meter. Alternate equipment may be used as long as the substitute equipment has specifications as good as or better than the equipment listed.

Description	Minimum Use Specifications	Recommended Equipment
<b>Output Voltage</b>	Range (0 to $\pm 1000$ ) DC V, accuracy $\pm 0.1\%$ of output	DC V Meter accuracy < 60 ppm or better, minimum 10 M $\Omega$ input impedance
<b>Auto Calibration Capacitor coefficients</b>	27 pF $\pm$ 200 000 ppm 270 pF $\pm$ 80 000 ppm 2700 pF $\pm$ 20 000 ppm	100 M $\Omega$ Reference Resistor, calibrated, max. Uncertainty 30 ppm
<b>Auto Calibration Threshold coefficients</b>	0.1 V $\pm$ 1000 ppm 1.0 V $\pm$ 1000 ppm	100 M $\Omega$ Reference Resistor, calibrated, max. Uncertainty 30 ppm
<b>Short Circuit</b>	0 ohm link	Guildline 65224
<b>Input Current (optional)</b>	Range ( $\pm 10$ m to $\pm 10\mu$ ) DC A $\pm$ 200 ppm	Fluke 5700A or equivalent

**Table 6-2: Recommended Calibration Test Equipment**

### 6.2.4. OUTPUT VOLTAGE CALIBRATION

Connect the Digital Voltmeter to the SOURCE connector of the 6530 under test (use the MHV-M to BANANA PLUG cable P/N 30046-01-21). Attach the TRIAX to type N cable to the INPUT connector.

Put the instrument into the SOFCAL DIAGNOSTIC Menu (reference Section 4.9.3)

Select the +1 V test voltage

Press the <Volts On/Off> function key to turn SOURCE output on.

Allow sufficient time for the DVM reading to stabilize. Record the reading displayed by the DVM. Press the <DN> key to select the next test voltage. Record each test voltage reading (Vdvm) for each test voltage (+1 V through +1000 V and -1 V through -1000 V). Press the <Volts On/Off> key to turn the SOURCE output OFF. For each test voltage record the actual voltage read.

- Press the <PREVIOUS> key to exit to the Sofcal Diagnostic Menu.
- Press the <PREVIOUS> key to exit to the Sofcal Menu.
- Select the <Calibrate> function key
- Reference Section 4.9.2.2
- Verify the unit is in the <Calibrate> Menu
- Select the <Ref. Vals> function key
- Verify the unit is in the <Reference> Menu
- Select the <Serial Number> key
- Verify that the Serial Number displayed matches the serial number printed on the rear of the instrument and on the calibration report.
- Press the <PREVIOUS> key to exit to the Sofcal Reference Menu.
- Press the <PREVIOUS> key to exit to the Sofcal Calibrate Menu.
- Select the <Cal. Vals> function key
- Verify the unit is in the <Calibrate> Menu
- Select the <Test Volts> function key
- Verify the display indicates all test voltages and their current error coefficient.
- Select the <Edit> function key
- Use the numeric keys to enter the new test voltage coefficients (in ppm) calculated previously.
- Carefully check the entered number then press the <Ok> key to accept and store the new coefficients.
- Press the <PREVIOUS> key to exit back to the Sofcal Calibrate Menu.

### 6.2.5. AUTO CALIBRATION

The Auto Calibration routine is a built-in process in the 6530 that will calibrate all three capacitor and both threshold values with a single 100 M $\Omega$  traceable resistor. This process is an automatic sequencing of the Capacitor and Threshold Calibration routines which can be executed on an individual basis as described in Sections 6.2.6 and 6.2.7. To execute this process, follow the steps below.

**NOTE: This operation DOES change the coefficients and voids the previous calibration, both resistance and current. Upon completion the 6530 will have to be verified across the operation range.**

- Reference Section 4.9.2.1.1.
- Connect the 100 M $\Omega$  reference resistor between the SOURCE and INPUT terminals of the instrument.
- Select the SOFCAL CALIBRATE MENU by pressing the <Calibrate> function key when in the Sofcal Menu
- Press the <Ref Vals> function key.
- Press the <Ref Res> function key.
- Press the <Edit> function key.
- Using the numeric keys enter the new value of the reference resistor and its serial number
- New values for variance, standard deviation and sample size criteria for the 2700 pF capacitor may be entered using the numeric keypad if required (see Section 4.9.2.3.3)
- Repeat this process for the 270 pF and 27 pF capacitors, as well as the 1.0 V and 0.1 V thresholds.
- Press the <Ok> key to accept/store the new values.
- Press the <Cal Date> function key.
- Press the <Edit> function key to edit/re-enter the new calibration date.
- Press the <Ok> key to accept the new calibration date.
- Press the <PREVIOUS> key to exit back to the Sofcal Calibrate Menu.
- Press the <PREVIOUS> key to exit back to the Sofcal Calibrate Menu (top).
- Press the <Utilites> function key.
- Press the <Auto Cal.> function key.
- The 6530 will proceed to calibrate all three capacitors and the two thresholds.

**Note:** Ensure that the 100 M $\Omega$  reference resistor is connected. Press the <Auto Cal> key to start the automatic capacitor calibration sequence.

**Note:** When the calibration sequence is complete the instrument will prompt with the new calibration coefficient in the display window.

- The automated calibration sequence will run each measurement until it has satisfied variance and standard deviation requirements for the sample size of each test.
- If the requirements have not been met within the maximum number of retries the test is automatically stopped.
- If the test is completed fully, then acceptable results have been achieved. Press the <Save> key to save the results. This will update all capacitor coefficients and threshold coefficients.
- If the results are not acceptable then, you will need to return to the <Reference> Menu and adjust the test criteria to allow either more retries or a wider standard deviation/variance for the failed test.
- Press the <PREVIOUS> key to exit to the Sofcal Calibrate Menu.

### 6.2.6. CAPACITOR CALIBRATION

The Capacitor Calibration is a series of routines that are built in the 6530 to calibrate each of the three capacitors individually with the 100 M $\Omega$  traceable resistor. To execute this process, follow the steps below.

**NOTE: This operation DOES change the coefficients and voids the previous calibration, both resistance and current. Upon completion the 6530 will have to be verified across the operation range.**

- Reference Section 4.9.2.1.2.
- Connect the 100 M $\Omega$  reference resistor between the SOURCE and INPUT terminals of the instrument.
- Select the SOFCAL CALIBRATE MENU by pressing the <Calibrate> function key when in the Sofcal Menu
- Press the <Ref Vals> function key.
- Press the <Ref Res> function key.
- Press the <Edit> function key.
- Using the numeric keys enter the new value of the reference resistor and its serial number
- New values for variance, standard deviation and sample size criteria for the 2700 pF capacitor may be entered using the numeric keypad if required (see Section 4.9.2.3.3)
- Repeat this process for the 270 pF and 27 pF capacitors on XR and XPR Models.
- Press the <Ok> key to accept/store the new values.
- Press the <Cal Date> function key.
- Press the <Edit> function key to edit/re-enter the new calibration date.
- Press the <Ok> key to accept the new calibration date.
- Press the <PREVIOUS> key to exit back to the Sofcal Calibrate Menu.
- Press the <PREVIOUS> key to exit back to the Sofcal Calibrate Menu (top).
- Press the <Utilites> function key.
- Press the <Cap Cal.> function key.

**Note: Ensure that the 100 M $\Omega$  reference resistor is connected. Press the <Calc> key to start the automatic capacitor calibration sequence.**

**Note: When the calibration sequence is complete the instrument will prompt with the new calibration coefficient in the display window.**

- The automated calibration sequence will run each measurement until it has satisfied variance and standard deviation requirements for the sample size of each test.
- If the requirements have not been met within the maximum number of retries the test is automatically stopped.
- If the test is completed fully then acceptable results have been achieved. Press the <Save> key to save the results. This will update all capacitor coefficients.

- If the results are not acceptable then, you will need to return to the <Reference> Menu and adjust the test criteria to allow either more retries or a wider standard deviation/variance for the failed test.
- Press the <PREVIOUS> key to exit to the Sofcal Calibrate Menu.

### 6.2.7. THRESHOLD CALIBRATION

The Threshold Calibration is a series of routines that are built in the 6530 to calibrate each of the three capacitors individually with the 100 M $\Omega$  traceable resistor. To execute this process, follow the steps below.

**NOTE: This operation DOES change the coefficients and voids the previous calibration, both resistance and current. Upon completion the 6530 will have to be verified across the operation range.**

- Reference Section 4.9.2.1.3.
- Connect the 100 M $\Omega$  reference resistor between the SOURCE and INPUT terminals of the instrument.
- Select the SOFCAL CALIBRATE MENU by pressing the <Calibrate> function key when in the Sofcal Menu
- Press the <Ref Vals> function key.
- Press the <Ref Res> function key. 2844275
- Press the <Edit> function key.
- Using the numeric keys enter the value of the reference resistor and its serial number
- New values for variance, standard deviation and sample size criteria for the 1 V and 0.1 V thresholds may be entered using the numeric keypad if required (see Section 4.9.2.3.3)
- Press the <Ok> key to accept/store the new values.
- Press the <Cal Date> function key.
- Press the <Edit> function key to edit/re-enter the new calibration date.
- Press the <Ok> key to accept the new calibration date.
- Press the <PREVIOUS> key to exit back to the Sofcal Calibrate Menu.
- Press the <PREVIOUS> key to exit back to the Sofcal Calibrate Menu (top).
- Press the <Utilites> function key.
- Press the <Thresh Cal.> function key.

**Note: Ensure that the 100 M $\Omega$  reference resistor is connected. Press the <Calc> key to start the automatic capacitor calibration sequence.**

**Note: When the calibration sequence is complete the instrument will prompt with the new calibration coefficient in the display window.**



- The automated calibration sequence will run each measurement until it has satisfied variance and standard deviation requirements for the sample size of each test.
- If the requirements have not been met within the maximum number of retries the test is automatically stopped.
- If the test is completed fully then acceptable results have been achieved. Press the <Save> key to save the results. This will update all threshold coefficients.
- If the results are not acceptable then, you will need to return to the <Reference> Menu and adjust the test criteria to allow either more retries or a wider standard deviation/variance for the failed test.
- Press the <PREVIOUS> key to exit to the Sofcal Calibrate Menu.

### 6.2.8. ZERO COEFFICIENT CALIBRATION

The Zero Coefficient Calibration is a stand-alone routine that is built in the 6530 to calibrate the absolute value of the 100 k $\Omega$  protection resistor with the 100 M $\Omega$  traceable resistor. To execute this process, follow the steps below.

- Reference Section 4.9.2.1.4.
- Remove the 100 M $\Omega$  reference resistor and replace it with a terminal 0 ohm link between SOURCE AND INPUT.
- Select the SOFCAL CALIBRATE MENU by pressing the <Calibrate> function key when in the Sofcal Menu
- Press the <Ref Vals> function key.
- Press the <Ref Zero> function key.
- Press the <Edit> function key.
- Using the numeric keys enter the new value of the reference resistor and its serial number.
- New values for variance, standard deviation and sample size criteria for the zero ohm calibration may be entered using the numeric keypad if required (see Section 4.9.2.3.4).
- Press the <Ok> key to accept/store the new values.
- Press the <Cal Date> function key.
- Press the <Edit> function key to edit/re-enter the new calibration date.
- Press the <Ok> key to accept the new calibration date.
- Press the <PREVIOUS> key to exit back to the Sofcal Calibrate Menu.
- Press the <PREVIOUS> key to exit back to the Sofcal Calibrate Menu (top).
- Press the <Utilites> function key.
- Press the <Zero Cal.> function key.

**Note:** Ensure that the 0 ohm link is connected. Press the <Calc> key to start the automatic capacitor calibration sequence.

**Note:** When the calibration sequence is complete the instrument will prompt with the new calibration coefficient in the display window.

- The automated calibration sequence will run each measurement until it has satisfied variance and standard deviation requirements for the sample size of each test.
- If the requirements have not been met within the maximum number of retries the test is automatically stopped.
- If the test is completed fully then acceptable results have been achieved. Press the <Save> key to save the results. This will update the protection resistor coefficient.
- If the results are not acceptable then, you will need to return to the <Reference> Menu and adjust the test criteria to allow either more retries or a wider standard deviation/variance for the failed test.
- Press the <PREVIOUS> key to exit to the Sofcal Calibrate Menu.

### 6.3. CALIBRATION REPORT

Prepare a tabulated results sheet similar to that shown in Table 6-3, using the data reported by the instrument during the calibration procedure of Section 6.2.

## MODEL 6530 TeraOhm Bridge-Meter

Serial Number: \_\_\_\_\_

Variant: \_\_\_\_\_

Test Voltage (volts)	Coefficient (ppm)	Limits ± (ppm)
1		1000
3		1000
10		1000
30		1000
100		1000
300		1000
1000		1000
-1		1000
-3		1000
-10		1000
-30		1000
-100		1000
-300		1000
-1000		1000

Capacitor pF	Coefficient (ppm)	Limits ± (ppm)
27		200000
270		80000
2700		20000

Threshold (Volts)	Coefficient (ppm)	Limits ± (ppm)
0.1		1000
1.0		1000

Sensor Coefficients	Gain (mV)	Offset (V)
Temperature		
Humidity		
Pressure		

Zero Coefficient: \_\_\_\_\_ Ohms ( )

Dated: \_\_\_\_\_

Calibrated by: \_\_\_\_\_

**Table 6-3: Sample Calibration Report Format**

## 6.4. CALIBRATION THEORY

After each resistance reading the integration time is converted to a resistance. The conversion from time to resistance is achieved using the formula:

$$\text{Resistance} = \frac{V_{\text{test}} \times T_{\text{integration}}}{2 \times C_{\text{integrator}} \times T_{\text{integrator}}} - R_{\text{protection}}$$

Where: Resistance is the value of the unknown resistor

$V_{\text{test}}$  is the test voltage from the 6530 source

$T_{\text{integration}}$  is the time for the integration

$C_{\text{integrator}}$  is the value of the integrator capacitor

$T_{\text{integrator}}$  is the threshold of the integrator

$R_{\text{protection}}$  is the value of the protection resistor.

The nominal values of each of the components in the equation are known except for the unknown resistance. The variances from the nominal values are determined during the calibration process using Sofcal utilities. The 6530 system software calls up the nominal value of each component and corrects each by use of the respective calibration coefficient before computing the resistance value.

### 6.4.1. $R_{\text{protection}}$ COEFFICIENT

The value of the protection resistor is measured by the instrument during calibration using a short circuit connection between the source and input connectors of the 6530 and is stored in the instrument's Non-Volatile memory.

### 6.4.2. $V_{\text{test}}$ COEFFICIENTS

The variance of the test voltage from its nominal value is determined during calibration by selecting each possible output voltage and measuring its absolute value with a precision voltmeter. The variance of the output voltage from its nominal value is computed in Parts Per Million (ppm) and entered into the instrument's Non-Volatile memory either from the front panel or through one of the bus interfaces (RS-232C or GPIB). It should be noted that there are (14) fourteen different coefficients computed, and stored in the instrument, one for each voltage of each polarity.

### 6.4.3. Cintegrator COEFFICIENTS

The exact value of the reference resistor (used during calibration to compute the capacitor and threshold variances) is entered into the instrument's Non-Volatile memory either from the front panel (see section 4) or through one of the bus interfaces.

The instrument computes the variance of each integration capacitor. A traceable Standard Reference resistor (100 M $\Omega$ ) is connected between the instruments source and input terminals. The instrument then takes readings of the Standard Reference resistance until the calibration criteria are met and computes an average resistance value with corrections for the source voltage and the protection resistor. Using the average resistance value and the reference resistance value a number representing the variance of the capacitor from its nominal value is computed. The capacitor coefficient is automatically stored into the instrument's Non-Volatile memory. (see Section 4.9.2.1.2)

### 6.4.4. Tintegrator COEFFICIENTS

The instrument also computes the variance of the integration thresholds. A known Standard Reference resistor (100 M $\Omega$ ) is connected between the instruments source and input terminals. The instrument then takes readings of the Standard Reference resistance until the calibration criteria are met and computes an average value with corrections for the source voltage, the integration capacitor and the protection resistor. The average value and the resistance value are used to compute a number representing the variance of the threshold from its nominal value. The threshold variance is automatically stored in the instruments Non-Volatile memory. The Tintegrator Coefficient for the 10 V threshold is assumed to be 0. (see Section 4.9.2.1.3)



# 7. TROUBLE SHOOTING AND MAINTENANCE

## 7.1. PREVENTATIVE MAINTENANCE

Preventative maintenance consists of cleaning and visual inspection of the instrument. Preventative maintenance performed on a regular basis will prevent instrument breakdown and will improve the reliability of this instrument. The severity of the environment to which the 6530 is subjected determines the frequency of maintenance. A convenient time to perform preventative maintenance is preceding recalibration of the instrument. Do not open the instrument for any of the described maintenance activities as removal the protective covering of the 6530 may cause rather than prevent problems.

The 6530 should be cleaned as often as operating conditions require. Accumulation of dirt in the instrument air filter can cause overheating and component breakdown due to improper airflow. These filters should be vacuumed out to keep a clear airflow. The dress skins also provide protection against dust in the interior of the instrument. Operation without these panels in place necessitates more frequent cleaning. However, it is recommended that you remove the dress skins to allow better access for vacuuming the air filter

Periodically inspect the instrument for general cleanliness.

### CAUTION

**Avoid the use of chemical cleaning agents that might damage the plastics used in this instrument. In particular, avoid chemicals that contain benzene toluene, xylene or similar solvents.**

Periodically check the diagnostics utility in the 6530 and confirm that there are no error conditions displayed.

Routinely run the artifact calibration procedure to ensure the 6530 is operating to full specifications. See Section 6.

If the instrument is not correctly functioning remove the cover and clean out any accumulated dust with a soft brush, at the same time check for discolored or damaged wiring. Check all screws and hardware for tightness. This should only occur as a corrective measure.

Note: A grounding wrist strap must be used to prevent electro-static discharge to sensitive components whenever the top cover is removed.

## 7.2. NON VOLATILE MEMORY CHECKSUM

The model 6530 TeraOhm Bridge-Meter contains a bank of memory into which certain operating data are written and stored. This memory is non-volatile in that data are kept even when power is removed from the instrument.

The integrity of the data in this memory is checked on power up and on an instrument RESET by comparing a stored checksum value with a calculated value. The two checksum values should agree. Occasionally, the stored checksum value may not agree with the newly calculated value (on RESET or Power Up) due to an operator error in entering new data into the non-volatile (NV) RAM or when the non-volatile (NV) RAM battery is low.

When this occurs the 6530 will display the message "NON-VOLATILE MEMORY FAILURE, Press any key to continue". The 6530 will restore factory-set default values and will calculate a new checksum, then reinitialize all non-volatile memory.

## 7.3. TROUBLESHOOTING

Symptom	Possible Cause
<b>No display</b>	Instrument not plugged into source of AC power. Instrument not powered ON. Power Supply fuse open. Cable between CPU PCB and Display PCB loose. Faulty connector on cable between CPU and Display PCB. Faulty Display PCB. Faulty CPU PCB. Faulty Power Supply PCB.
<b>Display on but no Keyboard response</b>	Keyboard switches locked out by remote controller. Cable between CPU and Display PCB loose. Faulty connector on cable between CPU and Display PCB. Faulty Display PCB.
<b>Display on but only partial Keyboard response</b>	Cable between CPU and Display PCB faulty. Faulty Display PCB.
<b>RS-232C no response</b>	Incorrect baud rate set. Talk/Listen mode not selected. RS-232C cable not connected to instrument properly. Cable from rear panel RS-232C connector to CPU PCB faulty. Faulty CPU PCB.



## 7.4. ERROR MESSAGES

Display Message	Comment
RAM FAILURE XX	RAM Test Failure in bank XX where XX is in the range 01 through 16.
FAST ADC FAILURE	Interrupt from the ADC has not been generated or has not been recognized
ADC NOT RUNNING	ADC converter not running correctly.
ADC OFFSET X.YZ	Ground (zero volts) input to MUX is out of range or MUX output offset magnitude too large. The measured offset is displayed as X.YZ volts.
ADC GAIN XXXX	The 10 V reference channel is measured and determined to be out of range. The measured unacceptable gain is displayed as XXXX.
ADC RATE XXX KHZ	The ADC interrupt rate is out of range as either too slow or too fast. The measured unacceptable rate is displayed as XXX KHZ.
+ 5 Volts X.XX	+ 5 V analogue power supply out of limits; measured X.XX V.
- 5 Volts X.XX	- 5 V analogue power supply out of limits; measured X.XX V.
+ 15 Volts X.XX	+ 15 V analogue power supply out of limits; measured X.XX V.
- 15 Volts X.XX	- 15 V analogue power supply out of limits; measured X > XX V.
PRECHARGE X.XX	Precharge Voltage out of limits; measured X.XX V.
HV MON X.XX	High Voltage monitoring point out of limits; measured X.XX V.
10 V REF X.XX	10 volt Reference point out of limits; measured X.XX V.
RAMP X.XX	Ramp Reference point out of limits; measured X.XX V.
Electrometer OFF	Ramp is not moving or integration time is too long.
Integration < 3ms	Ramp is moving to fast or integration time is too short.

<b>Display Message</b>	<b>Comment</b>
+ 5 Volts X.X	+ 5 V digital power supply out of limits; measured X.X V.
- 5 Volts X.X	- 5 V digital power supply out of limits; measured X.X V.
+ 15 Volts X.X	+ 15 V digital power supply out of limits; measured X.X V.
- 15 Volts X.X	- 15 V digital power supply out of limits; measured X.X V.

## 8. APPENDICES

### 8.1. GENERAL SPECIFICATIONS

<b>MODEL 6530 General Specifications</b>		
<b>Operating Temperature</b>	(23 ± 5) (73.4 ± 9)	°C °F
<b>Storage Temperature</b>	-20 to 60 -4 to 140	°C °F
<b>Operating Humidity (non-condensing)</b>	20 to 50	% rH
<b>Storage Humidity (non-condensing)</b>	15 to 80	% rH
<b>Power Requirements</b>	120	VA
<b>Voltage Requirements</b>	100; 120; 220; 240 ± 10%	V AC
<b>Line Frequency</b>	(50; 60) Hz ± 5%	Hz
<b>Dimensions (Nominal)</b>	D 500, W 17.5, H 89 D 19.7, W 17.5, H 3.5	mm in
<b>Weight</b>	11.4 25	kg lb

**Table 8-1: General Specifications**

**Note: Add 11mm (0.4 in.) to height for bench top feet.**

## 8.2. RESISTANCE MEASUREMENT SPECIFICATIONS

Note: The uncertainties listed in Table 8-2 are applicable after a four-hour warm-up period when using the autoranging mode of operation and when the current is no less than one picoampere through the unknown resistor. Many types of high value resistors can be difficult to measure accurately with the 6530 in autoreverse mode because their actual resistance value changes slowly for a period of time after a polarity reversal. They can however be measured to the full 6530 accuracy by allowing sufficient settling time between polarity reversals (soak time). This is done under manual control or through adjusting the 6530 parameters. The accuracy is traceable to the International System of Units (SI) through NRCC (Canada) or other National Metrology Institutes.

24 Hour Bridge Mode $\pm \mu\Omega/\Omega$ (ppm) 23 °C $\pm$ 5 °C					
Range ( $\Omega$ )	Range (Volts)	Base	XR	XP	XPR
90 k to 200 k	1 V	NA	50	NA	40
200 k to 2 M	1 V	25	15	8	8
2 M to 20 M	1 V	25	15	8	8
20 M to 200 M	1 V to 10 V	25	15	8	8
200 M to 2 G	1 V to 100 V	25	15	8	8
2 G to 20 G	1 V to 100 0V	25	20	10	10
20 G to 200 G	10 V to 1000 V	25	20	15	15
200 G to 2 T	100 V to 1000 V	80	70	50	50
2 T to 20 T	1000 V	500	200	120	120
20 T to 200 T	1000 V	700	500	200	200
200 T to 2 P	1000 V	NA	1500	NA	800
2 P to 20 P	1000 V	NA	3500	NA	2000

12 Month Uncertainty Direct Measurement $\pm \mu\Omega/\Omega$ (ppm) 23 °C $\pm$ 5 °C					
Range ( $\Omega$ )	Range (Volts)	Base	XR	XP	XPR
90 k to 200 k	1 V	NA	200	NA	150
200 k to 2 M	1 V	250	200	150	150
2 M to 20 M	1 V	250	200	150	150
20 M to 200 M	1 V to 10 V	150	100	80	80
200 M to 2 G	1 V to 100 V	200	150	150	150
2 G to 20 G	10 V to 1000 V	600	500	400	400
20 G to 200 G	10 V to 1000 V	800	700	600	600
200 G to 2 T	100 V to 1000 V	1200	1100	1000	1000
2 T to 20 T	1000 V	3500	3000	2500	2500
20 T to 200 T	1000 V	6000	5000	4000	4000
200 T to 2 P	1000 V	NA	20,000	NA	15,000
2 P to 20 P	1000 V	NA	250,000	NA	200,000

**Table 8-2: Resistance Measurement Uncertainty**

## 8.3. PICOAMMETER MEASUREMENT SPECIFICATIONS

Note: The uncertainties listed in Table 8-3 are applicable after a one-hour warm-up period when using the autoranging mode of operation. The accuracy is traceable to the International System of Units (SI) through NRCC (Canada) or other National Metrology Institutes.

12 Month Uncertainty Direct Measurement $\pm$ % 23 °C $\pm$ 5 °C				
Range (A)	Base	XR	XP	XPR
1uA $\leq$ I < 10uA	0.1	0.1	0.1	0.1
100nA $\leq$ I < 1uA	0.1	0.1	0.1	0.1
10nA $\leq$ I < 100nA	0.2	0.2	0.2	0.2
1nA $\leq$ I < 10nA	0.2	0.2	0.2	0.2
100pA $\leq$ I < 1nA	0.2	0.2	0.2	0.2
10pA $\leq$ I < 100pA	1	1	1	1
1pA $\leq$ I < 10pA	N/A	5	N/A	5
100fA $\leq$ I < 1pA	N/A	20	N/A	20

**Table 8-3: Current Measurement Uncertainty (All Models)**

## 8.4. RESOLUTION

When the Model 6530 is used with short integration time periods, the measurement resolution is limited by the quantization error in the time measuring circuit (plus or minus one clock period). When the quantization error is not significant, the display resolution is truncated at a value commensurate with the short-term measurement stability. The measurement display resolution can be set by the user using the **Set Up Menu** option. The default resolution is fixed at 6 digits. If the <Auto res> option is selected then the instrument will set the resolution based on Table 8-4.

Integrating Capacitor	Display Resolution (Digits)				
	Integration Time				
pF	5.4 mSec	54 mSec	540 mSec	5.4 Sec	Up To 20000 Sec
27	5	5	6	6	5
270	5	6	7	7	7
2700	6	7	7	7	7

**Table 8-4: Measurement Resolutions (Digits)**

**Note: The measurements can be performed with reduced accuracy for integration times less than 5.4ms down to 3ms.**

## 8.5. SYSTEM PARAMETER

The table below describes the valid 6530 measurement setups along with the default parameters defined for each resistance/voltage range in auto-reverse mode. These parameters can be accessed and modified in the System parameter section of the 6530. It should be noted that modification of these parameters from the same in which the 6530 was calibrated invalidates the calibration. The 6530 comes from the factory calibrated to these default parameters.

Note:

- 1 The dark grey areas are the parameters and range selection that is used by the auto ranging function of the 6530. These represent the optimal measurement parameters for both Direct Measurement and Bridge Modes.
- 2 The light grey areas are areas in which the 6530 will measure in Direct Measurement mode to full-rated specifications. These alternate settings provide a method for voltage coefficient testing. Bridge Mode is also valid in these areas.
- 3 The white areas in the table are measurements the 6530 can make but are not specified or calibrated for Direct Measurement and are only valid for Bridge Mode.

**6530-B and 6530-XP Models**

Base/XP	Nominal	Test V	Cap.	Thesh.	Ramp	Auto?	Count	Size
<b>2M to 20M</b>	10M	1	2700	10	0.54	*	17	20
	10M	2	2700	10	0.18		17	20
	10M	10	2700	10	0.054		38	45
	10M	30	2700	10	0.018		58	65
	10M	100	2700	10	0.0054		90	100
<b>20M to 200M</b>	100M	1	2700	10	5.4	*	18	21
	100M	3	2700	10	1.8		36	40
	100M	10	2700	10	0.54		36	40
	100M	30	2700	10	0.18		17	20
	100M	100	2700	10	0.054		38	45
	100M	300	2700	10	0.018		58	65
	100M	1000	2700	10	0.0054		90	100
<b>200M to 2G</b>	1G	1	2700	1	5.4		45	50
	1G	3	2700	1	1.8		45	50
	1G	10	2700	10	5.4	*	8	12
	1G	30	2700	10	1.8		8	12
	1G	100	2700	10	0.54		8	12
	1G	300	2700	10	0.18		17	20
	1G	1000	2700	10	0.054		38	45
<b>2G to 20G</b>	10G	1	2700	0.1	5.4		45	50

	10G	3	2700	0.1	1.8		40	45
	10G	10	2700	1	5.4		18	21
	10G	30	2700	1	1.8		8	12
	10G	100	2700	10	5.4	*	8	12
	10G	300	2700	10	1.8		8	12
	10G	1000	2700	10	0.54		8	12
<b>20G to 200G</b>	100G	10	2700	0.1	5.4		12	20
	100G	30	2700	0.1	1.8		28	36
	100G	100	2700	1	5.4		12	20
	100G	300	2700	1	1.8		12	20
	100G	1000	2700	10	5.4	*	12	20
<b>200G to 2T</b>	1T	100	2700	0.1	5.4		12	20
	1T	300	2700	0.1	1.8		12	20
	1T	1000	2700	1	5.4	*	12	20
<b>2T to 20T</b>	10T	1000	2700	0.1	5.4	*	45	50
<b>20T to 200T</b>	100T	1000	2700	0.1	54	*	45	50

### 6530-XR and 6530-XPR Models

Range	Nominal	Test V	Cap.	Thesh.	Ramp	Auto?	Count	Size
<b>90k to 200k</b>	100k	1	2700	10	0.0054	*	90	100
<b>200k to 2M</b>	1M	1	2700	10	0.054	*	45	50
	1M	3	2700	10	0.018		58	65
	1M	10	2700	10	0.0054		90	100
<b>2M to 20M</b>	10M	1	2700	10	0.54	*	17	20
	10M	2	2700	10	0.18		17	20
	10M	10	2700	10	0.054		38	45
	10M	30	2700	10	0.018		58	65
	10M	100	2700	10	0.0054		90	100
<b>20M to 200M</b>	100M	1	2700	10	5.4	*	18	21
	100M	3	2700	10	1.8		36	40
	100M	10	2700	10	0.54		36	40
	100M	30	2700	10	0.18		17	20
	100M	100	2700	10	0.054		38	45
	100M	300	2700	10	0.018		58	65
	100M	1000	2700	10	0.0054		90	100
<b>200M to 2G</b>	1G	1	2700	1	5.4		45	50
	1G	3	2700	1	1.8		45	50
	1G	10	2700	10	5.4	*	8	12

	1G	30	2700	10	1.8		8	12
	1G	100	2700	10	0.54		8	12
	1G	300	2700	10	0.18		17	20
	1G	1000	2700	10	0.054		38	45
<b>2G to 20G</b>	10G	1	2700	0.1	5.4		45	50
	10G	3	2700	0.1	1.8		40	45
	10G	10	2700	1	5.4		18	21
	10G	30	2700	1	1.8		8	12
	10G	100	2700	10	5.4	*	8	12
	10G	300	2700	10	1.8		8	12
	10G	1000	2700	10	0.54		8	12
<b>20G to 200G</b>	100G	1	270	0.1	5.4		45	50
	100G	3	270	0.1	1.8		12	20
	100G	10	2700	0.1	5.4		12	20
	100G	30	2700	0.1	1.8		28	36
	100G	100	2700	1	5.4		12	20
	100G	300	2700	1	1.8		12	20
	100G	1000	2700	10	5.4	*	12	20
<b>200G to 2T</b>	1T	1	27	0.1	5.4		45	50
	1T	3	27	0.1	1.8		12	20
	1T	10	270	0.1	5.4		12	20
	1T	30	270	0.1	1.8		12	20
	1T	100	2700	0.1	5.4		12	20
	1T	300	2700	0.1	1.8		12	20
	1T	1000	2700	1	5.4	*	12	20
<b>2T to 20T</b>	10T	10	27	0.1	5.4		45	50
	10T	30	27	0.1	1.8		45	50
	10T	100	270	0.1	5.4		45	50
	10T	300	270	0.1	1.8		45	50
	10T	1000	2700	0.1	5.4	*	45	50
<b>20T to 200T</b>	100T	100	27	0.1	5.4		25	30
	100T	300	27	0.1	1.8		25	30
	100T	1000	270	0.1	5.4	*	25	30
<b>200T to 2P</b>	1P	1000	27	0.1	5.4	*	45	50
<b>2P to 20P</b>	10P	1000	27	0.1	54	*	45	50

**Table 8-5: Default System parameter**



## 8.6. SAMPLE BUS CONTROL PROGRAM

The following is a brief note on how to configure a National Instruments GPIB-PC controller card when used with the 6530. A program outline is provided that collects data using the National Instruments GPIB-PC interface.

Assuming that the National Instrument driver has been installed with all the default naming, the device name for ADDRESS 4 will be "DEV4", and could be used to control the 6530.

The "DEV4" should be configured as follows:

- Default device name: DEV4
- GPIB address (fixed): 4
- Secondary address: none
- Timeout setting: 3 seconds
- Serial poll timeout: 3 seconds
- Terminate read on EOS: YES
- Set EOI with EOS on write: YES
- Type of compare on EOS: 7 bit
- EOS byte: 0A hex
- Send EOI at end of writes: YES
- Enable repeat addressing: YES
  
- Programming Note 1 : BASIC

### Sample Bus Control Program Using Basic And National Instruments GPIB-PC Controller

```

100 REM BASIC Example Program - for Guildline Model 6530 Teraohm Bridge-
    Meter
110 REM 6530
120 REM
130 REM You MUST merge this code with DECL.BAS.
140 REM
150 REM Assign a unique identifier to device and
160 REM store in variable DEV%.
170 REM
180   BDNAME$ = "DEV4"
190   CALL IBFIND (BDNAME$, DEV%)
200 REM
210 REM Check for error on IBFIND call.
220 REM
230   IF DEV% < 0 THEN GOSUB 2000
240 REM
250 REM Clear the device.
260   CALL IBCLR (DEV%)
270 REM
280 REM Check for an error on each GPIB call to be
    safe.
290 REM
300 REM

```

```
320 IF IBSTA% < 0 THEN GOSUB 3000
330 REM
330 REM Tell the 6530 Teraohm Bridge-Meter to measure resistance
340 REM
350 WRT$ = "MEAS ON"
360 CALL IBWRT (DEV%,WRT$)
370 IF IBSTA% < 0 THEN GOSUB 3000
380 REM
390 REM Loop on reading the status byte until
400 REM the 6530 says that the reading is complete
410 REM Check that the 6530 is still measuring.
420 REM If not measuring then an error has occurred
430 WRT$ = "MEAS?"
440 CALL IBWRT (DEV%,WRT$)
450 IF IBSTA% < 0 THEN GOSUB 3000
460 RD$ = SPACE$(48)
470 CALL IBRD (DEV%,RD$)
480 IF IBSTA% < 0 THEN GOSUB 3000
490 IF RD$ <> "On" THEN GOTO 4000
500 REM Prevent timeout on Voltage Source
510 WRT$ = "CONF:TEST:VOLT CONT"
520 CALL IBWRT (DEV%,WRT$)
530 IF IBSTA% < 0 THEN GOSUB 3000
540 REM
550 REM Now test the status byte (STB).
560 REM If STB has bit 2 set then the 6530 Teraohm Bridge-Meter
570 REM has finished its reading otherwise
580 REM loop around
590 REM
600 WRT$="*STB?" : CALL IBWRT (DEV%,WRT$)
610 IF IBSTA% < 0 THEN GOSUB 3000
620 RD$ = SPACE$(48) : CALL IBRD (DEV%,RD$)
630 IF IBSTA% < 0 THEN GOSUB 3000
640 IF VAL(RD$) AND &H02 THEN GOTO 700
650 GOTO 430
660 REM
670 REM Ask the 6530 Teraohm Bridge-Meter to give us the next
680 REM measurement
690 REM
660 WRT$ = "READ:RES?" : CALL IBWRT (DEV%,WRT$)
700 IF IBSTA% < 0 THEN GOSUB 3000
710 RD$ = SPACE$(48) : CALL IBRD (DEV%,RD$)
720 IF IBSTA% < 0 THEN GOSUB 3000
730 REM
740 REM Print out the reading and loop around to catch
750 REM the next reading
760 REM
770 PRINT RD$
780 GOTO 430
2000 REM A routine at this location would notify
2010 REM you that the IBFIND call failed, and
2020 REM refer you to the handler software
2030 REM configuration procedures.
2040 PRINT "IBFIND ERROR" : RETURN
3000 REM An error checking routine at this
```

```
3010 REM location would, among other things,  
3020 REM check IBERR to determine the exact  
3030 REM cause of the error condition and then  
3040 REM take action appropriate to the  
3050 REM application. For errors during data  
3060 REM transfers, IBCNT may be examined to  
3070 REM determine the actual number of bytes  
3080 REM transferred.  
3090 PRINT "GPIB ERROR" : RETURN  
4000 REM An error routine to tell you that the measurement  
4010 REM terminated prematurely  
4020 PRINT "ERROR, TEST TERMINATED PREMATURELY."  
4030 REM  
5000 END
```

### 8.7. MEASUREMENT TECHNIQUE

#### 8.7.1. LARGE VALUE RESISTOR MEASUREMENT TECHNIQUE

The measurement of very large value resistors presents special challenges for the operator. The measurement is often rendered meaningless unless certain precautions are taken.

#### 8.7.2. ENVIRONMENT

The test equipment and the test sample should be located in a clean dry area where the temperature is relatively constant near 23°C. The air humidity should be between 20 %rH and 40 % rH. Ionized air and ionizing radiation should not be present in the test area.

#### 8.7.3. SAMPLE PREPARATION

It is very important to prepare the test sample properly so that unwanted parallel leakage paths are reduced as much as possible. The condition of the insulation surface between the sample terminals is very critical since this usually forms a significant source of electrical leakage. The surface must be dry and free of conductive salts or other deposits.

#### 8.7.4. TEST LEAD ROUTING

Although it is good general practice to use shielded test leads (shielded wires with the shields connected to ground) it is especially important with higher value test resistors. Shielded test leads shunt unwanted leakage current away from the electrometer circuit.

#### 8.7.5. CAPACITIVE TEST SAMPLES

Test samples that store electrical charges and have long time constants can be difficult to measure using the autoreverse feature of the TeraOhm Bridge-Meter. You can adjust the autoreverse parameters or, deactivate autoreverse until a stable resistance reading is displayed with one test voltage polarity and then manually reverse the polarity. The reading from both polarities should be recorded and an average computed.

The true resistance of the sample is the numerical average calculated from the two readings taken. This technique allows the sample sufficient time to be measured properly.

### 8.8. OTHER FEATURES

- \* Mounting: Bench top with extra flanges provided separately for 19-inch rack mounting.
- \* Input Connector: Front panel with rear panel access optional on request.
- \* Power Selection Switch: On rear panel.
- \* IEEE488.2 Connector: On rear panel.
- \*RS232 Connector: On rear panel

## 8.9. ACCESSORY EQUIPMENT

### 8.9.1. Environmental Monitor Model 65220



Temperature/Humidity  
Module



Pressure  
Module

#### Temperature/Humidity Sensor Specifications

##### 8.9.1.1. Humidity

###### Features

- \* Low power design
- \* High accuracy
- \* Fast response time
- \* Stable, low drift performance
- \* Chemically resistant

##### 8.9.1.2. RH Sensor Specification

Sensor construction consists of a planar capacitor with a second polymer layer to protect against dirt, dust, oils and other hazards.

RH Accuracy	$\pm 2\%$ RH, 0-100 % RH non-condensing, 25 °C, 5 VDC supply
RH Interchangeability	$\pm 5\%$ RH, 0-60% RH; $\pm 8\%$ @ 90% RH Typical
RH Linearity	$\pm 0.5\%$ RH Typical
RH Hysteresis	$\pm 1.2\%$ of RH Span Maximum
RH Repeatability	$\pm 0.5\%$ RH
RH response time	15 s in slowly moving air @ 25 °C
RH Stability	$\pm 1\%$ RH Typical at 50% RH in 5 Years
Operating Humidity Range	0 to 100% RH, non-condensing
Operating Temperature Range	-40 °C to 85 °C (-40 °F to 185 °F)
Temperature Compensation	True RH = Sensor RH/(1.0546-0.00216T) T in °C (True RH = Sensor RH/(1.093-0.0012T) T in °F)

Note: The Temperature Compensation is NOT factored in with the humidity displayed on the 6530.

### 8.9.1.3. Precision Centigrade Temperature Sensor

The temperature sensors are precision integrated-circuit temperature sensors, whose output voltage is linearly proportional to the Celsius (Centigrade) temperature. The sensor thus has an advantage over linear temperature sensors calibrated in ° Kelvin, as the user is not required to subtract a large constant voltage from its output to obtain convenient Centigrade scaling. The sensor does not require any external calibration or trimming to provide typical accuracies of  $\pm 1/4$  °C at room temperature and  $\pm 3/4$  °C over a full -55 °C to +150 °C temperature range. The low output impedance, linear output, and precise inherent calibration make interfacing to readout or control circuitry especially easy. As it draws only 60  $\mu$ A from its supply, it has very low self-heating, less than 0.1°C in still air. The sensor is rated to operate over a -55 °C to + 150 °C temperature range.

### 8.9.1.4. Pressure Sensor

The piezoresistive transducer is a state-of-the-art monolithic silicon pressure sensor designed for a wide range of applications, but particularly those employing a microcontroller or microprocessor with A/D inputs. This patented, single element transducer combines advanced micromachining techniques, thin-film metallization, and bipolar processing to provide an accurate, high level analog output signal that is proportional to the applied pressure.

#### Features

- Patented Silicon Shear Stress Strain Gauge
- Durable Epoxy Unibody Element

### 8.9.1.5. Integrated Pressure Sensor Specifications

0 to 100 kPa (0 to 14.5 psi): 15 to 115 kPa (2.18 to 16.68 psi)  
0.2 to 4.7 Volts Output

#### Pressure Sensor Device Data

#### MAXIMUM RATINGS

Parameter	Symbol	Value	Unit
Maximum Pressure	P max	400	kPa
Storage Temperature	T stg	-40° to +125°	°C
Operating Temperature	T A	-29° to +60°	°C

NOTE: Exposure beyond the specified limits may cause permanent damage or degradation to the device.

Pressure Offset (as configured - 0 to 60°C)			
V S = 5.0 Volts	V off	0.088	Vdc
Full Scale Output (as configured - 0 to 60°C)			
V S = 5.0 Volts	V FSO	4.587	Vdc
Full Scale Span (as configured - 0 to 60°C)			
V S = 5.0 Volts	V FSS	4.500	Vdc
Accuracy		±2.5 %	V FSS

### 8.9.2. Surface/Volume Resistivity Test Fixture Model 65221

This optional accessory allows the 6530 user to make direct measurement of volume resistivity up to  $10^{18}\Omega\text{-cm}$  (on samples 1 mm thick) and surface resistivity up to  $10^{17}\Omega/\text{square}$ , in accordance with ASTM procedures. A Keithley model 8009 test fixture is supplied with all the necessary interconnect cables for the 6530. A simple series of keystrokes on the 6530 front panel controls, starts the measurement process.



#### Resistivity Fixture Device Data

Operating Temperature:  $-30\text{ }^{\circ}\text{C}$  to  $+85\text{ }^{\circ}\text{C}$ ,  
 Operating Humidity: 65% R.H. (up to  $35\text{ }^{\circ}\text{C}$ , derate 3% R.H./ $^{\circ}\text{C}$  above  $35\text{ }^{\circ}\text{C}$ . )  
 Storage Temperature:  $-25\text{ }^{\circ}\text{C}$  to  $+85\text{ }^{\circ}\text{C}$ .  
 Dimensions: 108mm high  $\times$  165mm wide  $\times$  140mm deep (4 1/4in  $\times$  6 1/2 in  $\times$  5 1/2 in).  
 Weight: 1.45kg (3.19 lbs).

### 8.9.3. Calibration Resistors

Precision resistors are available (see Table 8-5) for calibrating the 6530. Each is supplied in a shielded enclosure with two male type N connectors spaced to allow connection to the 6530. To meet the accuracy of the specification in Table 8-2 and Table 8-3, a precision 100 M $\Omega$  resistor is recommended for calibration of error coefficients.

Other Calibration Resistors are available in ascending decades from 100 G $\Omega$  to 100 T $\Omega$  as well as special values on request. These precision resistors are typically used as check standards or transfer standards.



**Note:** The 6530 will accept only a resistor of approximately 100 MΩ with an uncertainty better than  $\pm 50$  ppm for setting the capacitor and threshold error coefficients.

Model	Nominal Resistance Value (Ohms)	Nominal Initial Tolerance ( $\pm$ ppm) (Note 1)	Calibration Uncertainty @23°C $\pm$ °C ( $\pm$ ppm) (Note 2)	Stability 12 Months ( $\pm$ ppm)	Temperature Coefficient 18-28°C (ppm/°C)	Voltage Coefficient (ppm/volt) (Note 3)
65224/0	0	n/a	n/a	n/a	n/a	n/a
9336/10M	10 M	25	15	10	<5	<0.1
9336/100M	100 M	50	<25	25	<5	<0.5
9336/1G	1 G	100	<80	35	<6	<0.5
9336/10G	10 G	200	<100	100	<25	<1
9336/100G	100 G	500	<500	200	<250	<1
9337/1T	1 T	1000	<1000	500	<300	<2
9337/10T	10 T	3000	<4500	750	<500	<2
9337/100T	100 T	5000	<5500	1000	<800	<2
9337/1P	1 P	20000	<10000	2000	<1000	<2
9337/10P	10 P	100000	<50000	5000	<10000	<2

**Table 8-6: Calibration Resistors**

**Note 1:** Nominal Initial Tolerance is the maximum variation of resistance mean value as adjusted initially at point of sale.

**Note 2:** Calibrated at 23°C, referred to the unit of resistance traceable to a National Metrology Institute, and expressed as a total uncertainty with a coverage factor of k=2.

**Note 3:** Maximum Voltage Rating: 1000 DC V.

**Note 4:** The 100 MΩ resistor is **strongly recommended** to maintain a total uncertainty ratio of 4:1 for the 6530.

### 8.9.4. Small Shielded Enclosure

The model 65223 Small Enclosure provides a stable shielded environment for measuring high resistances and the leakage resistance of capacitors. The sample capacitor should be connected between the "Source" and "C" terminals. This inserts a 10 MΩ resistor in series with the Capacitor to limit inrush currents.

#### **CAUTION**

**Hazardous voltages may be present at the SOURCE terminal. Ensure that the 6530 source is turned off before opening the 65223 cover.**

Inside dimensions:     138 × 112 × 60 (mm)  
                                   5.375 × 4.375 × 2.375 (ins)

### 8.9.5. Large Shielded Enclosure

The model 65222 Large Enclosure provides a stable shielded environment for measuring high resistances.

#### **CAUTION**

**Hazardous voltages may be present at the SOURCE terminal. Ensure that the 6530 source is turned off before opening the 65222 cover. The box of the enclosure should always be connected to the ground lug on the rear panel of the 6530.**

Inside dimensions:     342 × 228 × 152 (mm)  
                                   13.5 × 9.0 × 6.0 (ins)

### 8.9.6. Lead Set Model 65225

The 6530 includes a cable that has a standard BNC End (connects to 6530 Source Input) to a Male "N" connector which is the standard input for the Guildline 9336 and 9337 Source (Female "N" Connection. The 6530 standard cable set also includes one cable with a Triax End (Connects to 6530 Input) to Male "N" type cable which is the standard input for the Guildline 9336 and 9337 "Output" connections.

The 65225 lead set includes the additional cables, connectors and adaptors.

Qty	Part Number	Description
1	30053-02-21	1.8 m coax cable - MHV M to Type N,F
1	30054-02-21	1.8 m triax cable – M to Type N F
1	30055-01-21	1.8 m coax cable – MHV M both ends
1	30046-01-21	1.8 m cable – MHV M to Plug
1	054-20504	alligator clip set
1	997-09223	0.9 m cable, triax M to alligator
1	997-09224	0.9 m cable, Triax M to Triax M
1	003-23237	adapter, Triax F to Triax F

### 8.9.7. Calibration Kit Model 65226

This kit contains the following items:

- Two 1 meter (39-inch) extension cables fitted with a type N female connector on one end and mating coaxial connectors on the other end for connection to the 6530 front panel Source and Input connectors.
- Type N connector to binding post adapter.
- One Zero Ohm link Model 65224
- One Precision resistor Model 9336/100M

### 8.9.8. Zero Link Model 65224

This option contains a cable with an internal zero Ohm link used in the calibration of the 6530.

### 8.9.9. IEEE Interface Accessories

This option allows the connection of the 6530 to a Personal Computer or Laptop for software and remote control.

Interface	Supported OS	Description
IEEE PCI	Win 95 to Win XP	PCI IEEE-488.2 Interface Card (for PC only)
IEEE USB	Win 2K to Win 7	USB IEEE-488.2 Interface (for Laptop/PC) *** Recommended
IEEE PCMCIA	Win 95 to Win XP	PCMCIA IEEE-488.2 Interface Card (for Laptop only)
IEEE Cable 1M	N/A	1 Meter, Double Shielded IEEE 488.2 Interface Cable
IEEE Cable 2M	N/A	2 Meter, Double Shielded IEEE 488.2 Interface Cable *** Recommended
IEEE Cable PCMCIA	N/A	1 Meter PCMCIA to IEEE Cable

**Table 8-7: IEEE Interfaces**

### 8.9.10. 6530/RC Report of Calibration

The 6530 Report of Calibration supplies the extended data for the calibration of your 6530 TeraOhm Bridge-Meter.

### 8.9.11. 6564 High Resistance Scanner

The 6564 High Resistance scanner is a high isolation switch for TΩ measurements providing isolation of over 100 PΩ. The 6564 when used with TeraCal, vastly increases the measurement throughput, and simplifies bridge transfers through automation. The 6564 can be provided in 8 or 16 channel configurations.